

**AC SERVO SYSTEMS**  
**EPS-B2 SERIES**  
**USER MANUAL**  
**(V1.05)**

## Contents

<b>HOW TO READ THE PARAMETERS?</b> .....	<b>6</b>
<b>SAFETY NOTICE</b> .....	<b>7</b>
<b>CHAPTER 1 PRODUCT INTRODUCTION</b> .....	<b>11</b>
1.1 PRODUCT INSPECTIONS .....	11
1.2 PRODUCT MODEL IDENTIFICATIONS .....	12
1.2.1 Description of nameplate .....	12
1.2.2 Model identifications .....	13
1.3 SERVO DRIVE AND MOTOR MATCHING TABLE .....	15
1.4 MAINTENANCE AND INSPECTIONS .....	16
1.5 NAME OF EACH PART OF THE SERVO DRIVER .....	16
<b>CHAPTER 2 INSTALLATIONS</b> .....	<b>17</b>
2.1 INSTALLATION DIRECTION AND SPACE .....	17
2.2 RECOMMENDED SPECIFICATIONS OF CIRCUIT-BREAKER AND FUSE .....	18
2.3 COUNTERING NOISE INTERFERENCE AND HIGHER HARMONICS .....	18
2.3.1 Installation of EMI filter .....	19
2.3.2 Connection of AC/DC reactor for suppression of higher harmonic .....	19
2.4 SELECTION OF REGENERATIVE RESISTORS .....	20
<b>CHAPTER 3 WIRINGS</b> .....	<b>21</b>
3.1 SYSTEM STRUCTURE AND WIRING.....	21
3.1.1 Servo system structure.....	21
3.1.2 Servo drive connectors & terminals.....	22
3.1.3 Main circuit wirings .....	22
3.2 WIRINGS BETWEEN SERVO DRIVE & SERVO MOTOR .....	24
3.2.1 Configurations & definitions of quick plug terminals .....	24
3.2.2 Configurations and definitions of aviation plug terminals.....	24
3.3 WIRINGS OF CN1 (RS485 COMMUNICATION) .....	25
3.4 WIRINGS OF CN2 (I/O SIGNALS) .....	25
3.4.1 Pin arrangement of CN2 connector .....	25
3.4.2 CN2 signal descriptions .....	27
3.4.3 Allocation of I/O signals .....	29
3.4.4 Examples of connection with upper controllers .....	36
3.5 WIRINGS OF CN3 (FEEDBACK FROM ENCODER TO SERVO DRIVE) .....	40
3.5.1 Pin arrangement of CN3 connector .....	40
3.5.2 Examples of CN3 connections.....	41
3.6 STANDARD WIRING DIAGRAMS .....	42
3.6.1 Position control .....	42
3.6.2 Speed/torque control .....	43
<b>CHAPTER 4 PANEL OPERATIONS</b> .....	<b>44</b>
4.1 PANEL OPERATOR .....	44

4.2 SWITCH BETWEEN DIFFERENT FUNCTIONS .....	44
4.3 STATUS CODE DISPLAY .....	45
4.4 MONITORING DISPLAY MODE (DP □□) .....	46
4.4.1 Contents of monitoring display mode.....	46
4.4.2 Example of operations at monitoring display mode (dP 00).....	46
4.5 PARAMETER MODE (PA □□□) .....	47
4.5.1 Remarks at parameter mode .....	47
4.5.2 Example of operations at parameter mode (PA100) .....	48
4.6 AUXILIARY FUNCTION MODE (AF □□).....	49
4.6.1 Contents of auxiliary function mode .....	49
4.6.2 Example of operations at auxiliary function mode (AF 05) .....	49
<b>CHAPTER 5 MONITORING DISPLAY PARAMETERS.....</b>	<b>50</b>
5.1 LIST OF MONITORING DISPLAY PARAMETERS .....	50
5.2 INPUT SIGNAL MONITORING (DP 12) .....	52
5.2.1 Operations of entering dP 12 .....	52
5.2.2 Explanations of dP 12 LED displays.....	52
5.2.3 Examples of dP 12 LED displays .....	53
5.3 OUTPUT SIGNAL MONITORING (DP 13).....	54
5.3.1 Operations of entering dP 13 .....	54
5.3.2 Explanations of dP 13 LED displays.....	54
5.3.3 Examples of dP 13 LED displays .....	55
5.4 INITIAL MONITORING DISPLAY AT POWER ON .....	55
5.5 DISPLAY RANGE OF DP 01~DP 06 .....	55
<b>CHAPTER 6 AUXILIARY FUNCTIONS.....</b>	<b>56</b>
6.1 LIST OF AUXILIARY FUNCTION PARAMETERS.....	56
6.2 DISPLAY OF ERROR LOGGING (AF 00).....	57
6.3 POSITION ASSIGNMENT (AF 01).....	58
6.4 JOG RUN (AF 02).....	59
6.5 PANEL LOCK (AF 03).....	60
6.6 CLEARANCE OF ALARM LOGGING (AF 04).....	61
6.7 PARAMETER INITIALIZATION (AF 05).....	62
6.8 ANALOG INSTRUCTION AUTOMATIC OFFSET ADJUSTMENT (AF 06).....	63
6.9 SPEED INSTRUCTION MANUAL OFFSET ADJUSTMENT (AF 07) .....	64
6.10 TORQUE INSTRUCTION MANUAL OFFSET ADJUSTMENT (AF 08) .....	65
6.11 OVERVIEW OF RELEVANT MOTOR PARAMETERS (AF 09).....	66
6.12 DISPLAY OF MAIN SOFTWARE VERSION OF SERVO DRIVE (AF 10).....	67
6.13 SETTING UP ABSOLUTE ENCODERS (AF 11).....	68
6.14 MANUAL DETECTION OF LOAD INERTIA (AF 15).....	69
<b>CHAPTER 7 JOG RUN.....</b>	<b>70</b>
7.1 PREPARATIONS BEFORE JOG RUN .....	70
7.2 JOG RUN BY PANEL OPERATIONS .....	70
7.3 STAND-ALONE JOG RUN WITH UPPER CONTROLLERS .....	70

7.3.1	Wiring & status check of input signal circuit .....	70
7.3.2	JOG run in position control mode.....	71
7.3.3	JOG run in speed control mode.....	72
7.4	JOG RUN WITH MECHANICAL CONNECTIONS .....	73
7.5	JOG RUN WITH A HOLDING BRAKE.....	73
<b>CHAPTER 8</b>	<b>SERVO OPERATIONS .....</b>	<b>74</b>
8.1	CONTROL MODE SELECTIONS .....	74
8.2	BASIC FUNCTION SETTINGS .....	75
8.2.1	S-ON settings.....	75
8.2.2	Switch of motor rotational directions .....	76
8.2.3	Overtravel (OT) settings.....	77
8.2.4	Holding brake settings .....	79
8.2.5	Selection of servo stop patterns at servo OFF .....	83
8.2.6	Instantaneous power off settings .....	84
8.2.7	Analog voltage output .....	85
8.3	USING ABSOLUTE ENCODERS.....	86
8.3.1	Absolute encoder selection.....	86
8.3.2	Using battery for absolute encoder.....	86
8.3.3	Battery replacement .....	87
8.3.4	Setting up absolute encoders (AF 11).....	87
8.4	POSITION CONTROL OPERATIONS .....	88
8.4.1	Parameter settings .....	88
8.4.2	Electronic gear.....	89
8.4.3	Position instructions.....	90
8.4.4	Smoothness.....	91
8.4.5	Positioning completed signal (COIN).....	92
8.4.6	Positioning near signal (NEAR).....	93
8.4.7	Pulse input inhibited (INHIBIT).....	93
8.5	SPEED CONTROL OPERATIONS.....	94
8.5.1	Parameter settings .....	94
8.5.2	Input signals.....	94
8.5.3	Instruction offset adjustment .....	96
8.5.4	Soft start.....	97
8.5.5	Speed instruction filter time constant.....	97
8.5.6	Zero-speed clamp function .....	98
8.5.7	Encoder signal output .....	99
8.5.8	Speed instruction reached (VCMP).....	101
8.6	TORQUE CONTROL OPERATIONS.....	102
8.6.1	Parameter settings .....	102
8.6.2	Input signals.....	103
8.6.3	Instruction offset adjustment .....	104
8.6.4	Speed limit in torque control mode.....	105
8.7	INTERNAL SPEED CONTROL.....	106
8.7.1	Parameter settings .....	107

8.7.2 <i>Input signals</i> .....	107
8.8 INTERNAL POSITION CONTROL .....	108
8.8.1 <i>Parameter settings</i> .....	109
8.8.2 <i>Input signals</i> .....	111
8.8.3 <i>Output signals</i> .....	114
8.9 HOMING FUNCTION .....	115
8.10 COMBINATION OF DIFFERENT CONTROL MODES .....	121
8.10.1 <i>Parameter settings</i> .....	121
8.10.2 <i>Input signal</i> .....	121
<b>CHAPTER 9 FAULT DIAGNOSIS .....</b>	<b>122</b>
9.1 ALARMS .....	122
9.2 WARNINGS .....	126
<b>CHAPTER 10 COMMUNICATIONS .....</b>	<b>127</b>
10.1 COMMUNICATION TERMINALS .....	127
10.2 COMMUNICATION PARAMETERS .....	127
10.3 COMMUNICATION PROTOCOL .....	128
10.3.1 <i>Encoding definitions</i> .....	128
10.3.2 <i>Byte structure</i> .....	129
10.3.3 <i>Communication data structure</i> .....	130
10.3.4 <i>Communication troubleshooting</i> .....	137
10.4 COMMUNICATION ADDRESS .....	138
<b>CHAPTER 11 PRODUCT SPECIFICATIONS .....</b>	<b>140</b>
11.1 SERVO DRIVE SPECIFICATIONS .....	140
11.1.1 <i>Basic specifications</i> .....	140
11.1.2 <i>Position/speed/torque control specifications</i> .....	141
11.1.3 <i>Servo drive dimensions</i> .....	142
11.2 SERVO MOTOR SPECIFICATIONS & DIMENSIONS .....	143
<b>CHAPTER 12 APPENDIX .....</b>	<b>146</b>
12.1 LIST OF MONITORING DISPLAY FUNCTIONS .....	146
12.2 LIST OF AUXILIARY FUNCTION PARAMETERS .....	148
12.3 LIST OF PARAMETERS .....	149

# How to read the parameters?

- **High place/Low place explanation**

Sometimes one parameter value is two parameter values combined together. For example, High place is 1234 and low place is 5678, then the combined value is 12345678.

Also for hexadecimal data can be 16-bit or 32-bit. 32-bit data consists of two 16-bit data (two parameters, high/low place). For example, 0781H data is 0001H and 0782H data is 013AH; then absolute encoder single turn data is 0001013AH.

- **Parameter 1/2/3/4 explanations**

Parameter	Function	Range	Unit	Default	Effective	Remarks
PA200	Position control switch	d.0000~d.1232	—	0000	Restart	

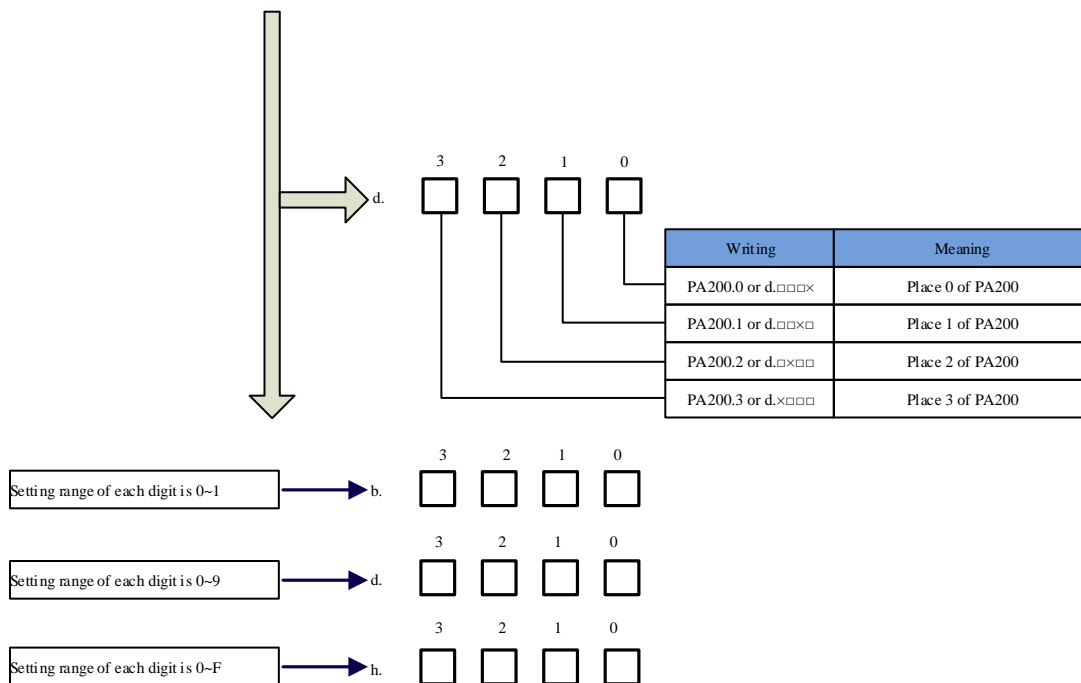

# Safety Notice

This section will introduce the main instructions that users shall follow during the receiving, storage, handling, installation, wiring, operation, inspection and disposal of the products.

## DANGER

### ■ Input power

Input power of the servo drive is 220VAC (-15%~+10%) or 380VAC (-15%~+15%).

### ■ When installed to a machine, the servo motor shall be able to do emergency stop at any moment.

Otherwise, there may be personnel injuries and mechanical failure.

### ■ When the power is on, the power supply terminals must be properly housed.

Otherwise, there may be electric shocks.

### ■ After power off or voltage withstand test, when the charge indication light (CHARGE) is on, do not touch the power supply terminals.

Otherwise, there may be electric shocks caused by residual voltage.

### ■ Please do trial run (JOG) following the procedures and instructions of this user manual.

Otherwise, there may be personnel injuries and mechanical failure.

### ■ Do not make any alterations to this product. Only qualified/designated persons can configure, dismantle or repair this product.

Otherwise, there may be personnel injuries, mechanical failure or fire.

### ■ Please install stop mechanisms on the machine side to ensure safety.

The holding brake of the servo motor is not a device designed to ensure safety.

Otherwise, there may be injuries.

### ■ Please ensure to connect the earth terminal of servo drive with the earth electrode (the earth resistance of servo drive for power input is below 100Ω).

Otherwise, there may be electric shocks or fire.

## ATTENTION: STORING & TRANSPORTING

### ■ The product shall not be stored or used in below environment:

(Otherwise, there may be fire, electric shocks or machinery breakdown.)

- The place with direct sun light;
- The place where temperature exceeds the limits for storage and using;
- The place where the relative humidity exceeds the limits for storage and using;
- The place with corrosive or flammable gases;
- The place with too much dust, dirt, and too many saline matters and metal powders;
- The place prone to water, oil and chemicals splashes;
- The place where vibrations or shocks may affect the principal parts.

### ■ Please do not transport the product by grasping the cables, motor shafts or encoders.

Otherwise, there may be personnel injuries or machine breakdown.

## ATTENTION: INSTALLATIONS

- **Please do not block the air inlet and outlet, and prevent alien matters entering the product.**  
Otherwise, the inner components may be aged and cause failure or fire.
- **Please install at correct directions.**  
Otherwise, there may be failure.
- **During installation, please ensure there is enough space between the servo drive and internal surface of control cabinet and other electrical parts.**  
Otherwise, there may be fire or machine breakdown.
- **Please do not impose too big impacts.**  
Otherwise, there may be machine breakdown.

## ATTENTION: WIRING

- **Please connect wires correctly and reliably.**  
Otherwise, there may be out-of-control of motor, personnel injuries or machine fault.
- **Please DO NOT connect commercial power supply to the UVW terminals of the servo drive.**  
Otherwise, there may be personnel injuries or fire.
- **Please connect the UVW terminals with the servo motor firmly.**  
Otherwise, there may be a fire.
- **Please do not house the main circuit cables, input-output signal cables and encoder cables with the same bushing, or tie them together. During wiring, the main circuit cables shall be at least 30cm from the input-output signal cable.**
- **Cables for input-output signal and encoder shall be twin strands or multiple-core twinning bulk shielding strands.**
- **Maximum length of input-output signal cable: 3m;  
Maximum length of encoder cable: 30m.**
- **Even when the power is turned off, there may still be residual high voltage inside the servo drive, so when the charge indication light (CHARGE) is on, do not touch the power terminals.**  
Please connect or check wirings after the charge indication light (CHARGE) is off.
- **Please install circuit breakers to prevent external short-circuit.**  
Otherwise, there may be a fire.
- **When used in the following places, please take appropriate measures for shielding:**
  - When there may be interference of static electricity
  - The place with strong electric field or high intensity field
  - The place where there may be radioactive raysOtherwise, there may be machinery breakdown.
- **When connecting to batteries, pay attention to the polarity.**  
Otherwise, it may lead to the damage and explosion of batteries, servo drive and servo motor.



## ATTENTION: OPERATIONS

- **In order to prevent accidents, please conduct trial run (JOG) before connecting to mechanical parts.**  
Otherwise, there may be injuries.
- **Before running, please set the appropriate parameters.**  
Otherwise, the machine may be out of control or have failure.
- **Please do not turn on/off the power supply frequently.**  
Because the power section of servo drive has capacitors, when the power is on, heavy charging current may flow through them. Therefore, if the power is frequently turned on/off, perseverance of the main circuit components inside the servo drive may decline.
- **During JOG operation (AF 02) and manual load inertia detection (AF 15), please note that the emergency stop will become ineffective at over-travel.**  
Otherwise, there may be machinery breakdown.
- **When the servo motor is used on the vertical axis, please set a safety device, in case workpiece drops when there is alarm or over-travel. Besides, please set up zero-position fixation when there is over-travel.**  
Otherwise, the workpiece may drop when there is over-travel.
- **Extreme or alternative parameter settings may cause the servo system to be instable.**  
Otherwise, there may be personnel injuries and machinery breakdown.
- **When there are alarms, please reset the alarm after finding out the causes and ensure operation safety, and then start operation again.**  
Otherwise, there may be machinery breakdown, fire or personnel injuries.
- **The holding brake (optional) of the servo motor is designed for maintaining positions, NOT for servo motor braking at decelerations.**  
Otherwise, there may be machine fault.
- **The servo motor and servo drive shall be used in combinations as specified.**  
Otherwise, there may be fire or machine breakdown.

## ATTENTION: MAINTENANCE

- **Please do not change the wiring when the power is on.**  
Otherwise, there may be electric shocks or personnel injuries.
- **When replacing the servo drive, please copy parameters to the new servo drive, and then start operation again.**  
Otherwise, there may be machinery breakdown.

## ATTENTION: OTHERS

- In order to give explicit explanations, housing or safety protection devices are omitted in some drawings in this user manual. During real operations, please make sure to install the housing or safety protection devices according to the instructions of the user manual.
- Illustrations in this manual are representative graphic symbols, which may be different from the products that you receive.
- During the commissioning and use of servo drive, please install the relevant safety protection devices. Our company will not bear any liability for the special losses, indirect losses and other relevant losses caused by our products.
- This manual is general descriptions or characteristic which may not always be the case in practical use, or may not be completely applicable when the products are further improved.

# Chapter 1 Product Introduction

## 1.1 Product inspections

Please check the items listed in the table below carefully, in case there is negligence during the purchase and transport of the product.

Items to inspect	Reference
Whether the product received is the right one you intend to buy?	Check the product model on the motor and driver nameplate respectively. Please refer to the notes to model in following sections.
Whether the motor shaft runs smoothly?	Rotate the rotor shaft of the motor. If it can rotate smoothly, the rotor shaft is normal. <b>Note that the motor with electro-magnetic brake (holding brake) cannot be rotated with hands!</b>
Check whether there are any appearance damages?	Check visually whether there are any appearance damages.
Whether there are loosened screws?	Check whether the mounting screws of servo drive is loosened with a screw driver.

Please contact your vendor if anything above occurs.

A complete set of servo components shall include the following:

No.	Reference
1	Servo drive and its matching servo motor.
2	Motor power line: supplies power from servo drive to servo motor.
3	Motor encoder line: transmits signals from motor encoder to servo drive.
4	RJ45 plug for CN1: RS485 communication (optional)
5	50-PIN plug for CN2 (3M simulation product) (optional)
6	20-PIN plug for CN3 (A, B type case only) (3M simulation product) (optional)
7	5-PIN plug for servo drive (A, B type case only) input power supply: L1. L2. L3. L1C. L2C
8	5-PIN plug for external braking resistor and DC reactor (A, B type case only) : (P, D, C, -1, -2)
9	Two metal pieces for short-circuiting (except E type case)
10	One copy of user manual

## 1.2 Product model identifications

### 1.2.1 Description of nameplate

- Description of the nameplates of EPS-B2 series servo drives

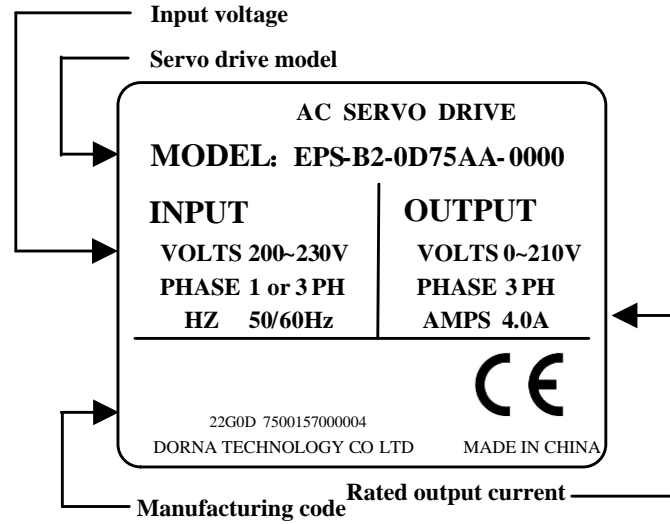

## 1.2.2 Model identifications

Note: drive and motor models can be updated from time to time. Please contact our after-sales service for updated information.

### ■ Description of the models of EPS-B2 servo drive



1 PRODUCT NAME: EPS

2 PRODUCT SERIES:  
B1 SERIES  
B2 SERIES

3 DRIVE RATED POWER

SYMBOL	DEFINITION	SYMBOL	DEFINITION
0D05	0.05KW	02D2	2.2KW
0D10	0.1KW	0003	3.0KW
0D20	0.2KW	04D5	4.5KW
0D40	0.4KW	05D5	5.5KW
0D75	0.75KW	07D5	7.5KW
0001	1.0KW	0011	11KW
01D2	1.2KW	0015	15KW
01D5	1.5KW	0022	22KW

4 INPUT VOLTAGE

SYMBOL	DEFINITION
A	SINGLE/THREE PHASE 220VAC
B	THREE PHASE 380VAC

5 HARDWARE VERSION

6 FACTORY CODE

■ Description of the models of DORNA servo motors

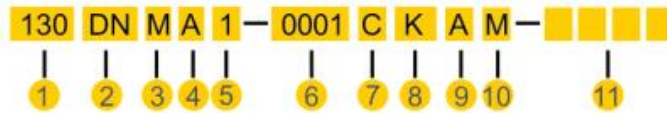

1 MOTOR FLANGE (MM)

SYMBOL	DEFINITION	SYM BOL	DEFINITION
40	40 MM FLANGE	130	130 MM FLANGE
60	60 MM FLANGE	180	180 MM FLANGE
80	80 MM FLANGE	200	200 MM FLANGE
110	110 MM FLANGE	220	220 MM FLANGE

2 PRODUCT NAME: DN

3 MOTOR ROTARY INERTIA

SYMBOL	DEFINITION
M	MEDIUM INERTIA
H	HIGH INERTIA

4 VOLTAGE CLASS

SYMBOL	DEFINITION
A	220V VOLTAGE CLASS
B	380V VOLTAGE CLASS

5 MOTOR POLE PAIRS

SYMBOL	DEFINITION
1	4 POLE PAIRS
2	5 POLE PAIRS

6 MOTOR RATED POWER

SYMBOL	DEFINITION	SYMBOL	DEFINITION
0D05	0.05KW	02D2	2.2KW
0D10	0.1KW	0003	3.0KW
0D20	0.2KW	04D5	4.5KW
0D40	0.4KW	05D5	5.5KW
0D75	0.75KW	07D5	7.5KW
0001	1.0KW	0011	11KW
01D2	1.2KW	0015	15KW
01D5	1.5KW	0022	22KW

7 MOTOR RATED SPEED

SYMBOL	DEFINITION	SYMBOL	DEFINITION
A	1000 RPM	D	3000 RPM
B	1500 RPM	E	2500 RPM
C	2000 RPM		

8 FEEDBACK DEVICE TYPE

SYMBOL	DEFINITION
K	5000-LINE (LINE SAVING, GAIN )
J	17-BIT SERIAL (ABSOLUTE)
S	20-BIT SERIAL (GAIN)
R	RESOLVER

9 MOTOR HOLDING BRAKE SELECTION

SYMBOL	DEFINITION
A	WITHOUT HOLDING BRAKE
B	WITH HOLDING BRAKE

10 KEY SLOT/OIL SEAL SELECTION

SYMBOL	KEY SOLT	OIL SEAL
K	YES	NO
Y	NO	YES
M	YES	YES
N	NO	NO

11 FACTORY CODE

### 1.3 Servo drive and motor matching table

Please select correct servo drive according to servo motor model, rated voltage, encoder type etc.

Voltage Class	Rated power	Servo drive			Servo motor			
		Model	PA012 Value	Case Type	Flange (mm)	Model	Rated speed	Rated torque
220V	0.05KW	EPS-B2-0D10AA	1	A	40	40DNMA2-0D05D	3000rpm	0.16 N·M
	0.1KW	EPS-B2-0D10AA	1	A	40	40DNMA2-0D10D	3000rpm	0.32 N·M
	0.2KW	EPS-B2-0D20AA	2	A	60	60DNMA2-0D20D	3000rpm	0.64 N·M
	0.4KW	EPS-B2-0D40AA	3	A	80	60DNMA2-0D40D	3000rpm	1.27 N·M
	0.75KW	EPS-B2-0D75AA	12	B	80	80DNMA2-0D75D	3000rpm	2.37 N·M
	1KW	EPS-B2-0001AA	13	B	80	80DNMA2-0001D	3000rpm	3.2 N·M
	1KW	EPS-B2-0001AA	33	B	130	130DNMA2-0001C	2000rpm	5 N·M
	1.2KW	EPS-B2-01D5AA	25	B	110	110DNMA2-01D2D	3000rpm	4 N·M
	1.2KW	EPS-B2-01D5AA	34	B	130	130DNMA2-01D2C	2000rpm	6 N·M
	1.5KW	EPS-B2-01D5AA	35	B	130	130DNMA2-01D5C	2000rpm	7.2 N·M
	1.5KW	EPS-B2-02D2AA	41	C	130	130DNMA2-01D5C	2000rpm	7.2 N·M
	1.8KW	EPS-B2-01D5AA	29	B	110	110DNMA2-01D8D	3000rpm	6 N·M
	2.2KW	EPS-B2-02D2AA	42	C	130	130DNMA2-02D2C	2000rpm	10.5 N·M
	3KW	EPS-B2-0003AA	45	C	130	130DNMA2-0003C	2000rpm	14.33 N·M
380V	2.2KW	EPS-B2-02D2BA	42	C	130	130DNMB2-02D2C	2000rpm	10.5 N·M
	3KW	EPS-B2-0003BA	45	C	130	130DNMB2-0003C	2000rpm	14.33 N·M
	3KW	EPS-B2-0003BA	70	C	180	180DNMB2-0003B	1500rpm	19.1 N·M

## 1.4 Maintenance and inspections

Please make regular maintenance and inspection of the drive and motor for safe and easy use. Routine and periodical inspections shall be carried out according to the following items

Type	Period	Items
Routine inspections	Daily	<ul style="list-style-type: none"> <li>• Whether there are dirt and or substances.</li> <li>• Whether there is abnormal vibration and sound</li> <li>• Whether the input supply voltage is normal</li> <li>• Whether there is abnormal smell</li> <li>• Whether there are fiber stubs stuck to the ventilation opening</li> <li>• Whether the front end of driver and the connector are clean</li> <li>• Whether there the connection with control device and equipment motor is loose and whether the core feet deviates</li> <li>• Whether there are foreign matters in the load part</li> </ul>
Periodical inspections	Yearly	<ul style="list-style-type: none"> <li>• Whether the fastening parts are loose</li> <li>• Whether it is superheated</li> <li>• Whether the terminal is damaged or loose</li> </ul>

## 1.5 Name of each part of the servo driver

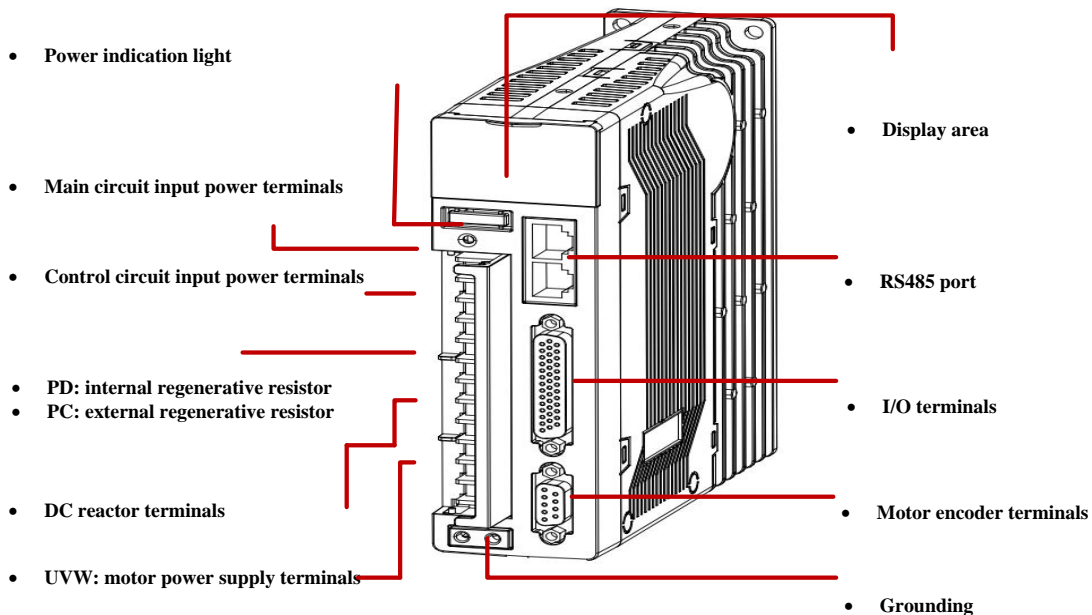



# Chapter 2 Installations

## 2.1 Installation direction and space

The installation direction must be in accordance with the regulations, otherwise it will cause malfunctions. In order to make a good cooling effect, the upper and lower, left and right with the adjacent items and baffle (wall) must have enough space, otherwise it will cause malfunctions. The AC servo drive's suction, exhaust hole cannot be sealed, nor placed upside down, otherwise it will cause malfunctions.

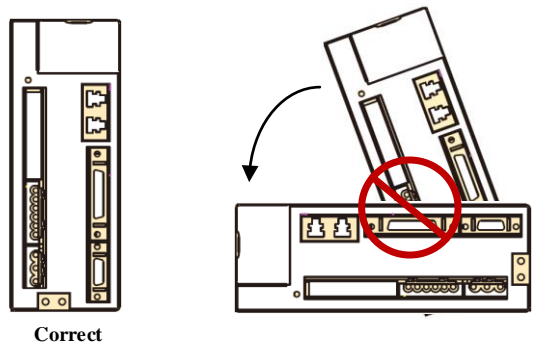

In order to lower the wind resistance to the radiator fan and let heat discharge effectively, users shall follow the recommended installation spacing distance of one or several AC servo drivers (see the figure below).

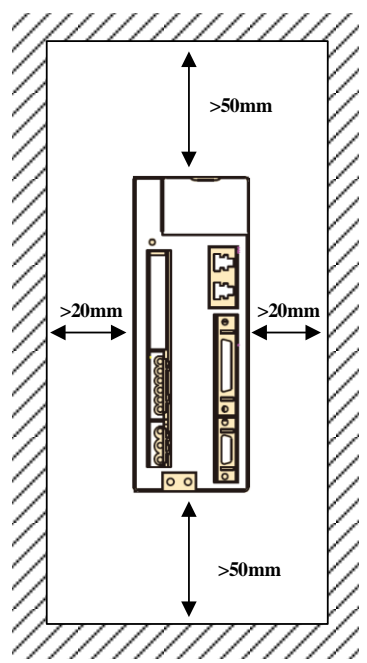

## 2.2 Recommended specifications of circuit-breaker and fuse

### ■ 220V class

Servo drive case type	Circuit-breaker	Fuse (class T)
<b>A</b>	10A	20A
<b>B</b>	20A	40A
<b>C</b>	30A	80A

Note:

1. Strongly recommended: the fuse and circuit-breaker must comply with UL/CSA standards.
2. When an earth leakage circuit breaker (ELCB) is added for leakage protections, please choose ELCB with sensitivity current over 200mA and action time over 0.1s.

## 2.3 Countering noise interference and higher harmonics

The main circuit of servo drive uses a high-speed switching device, so the peripheral wiring and earthing of servo drive may be affected by the noise of the switching device. In order to prevent noise, the following measures can be taken:

- ◆ Please install EMI filter on the main power supply side;
- ◆ Connection of AC/DC reactor for suppression of higher harmonic;
- ◆ Please install the command input equipment (such as PLC) and EMI filter as close as possible to the servo drive;
- ◆ The power line (cable for power supply from servo drive to servo motor) shall be over 30cm from the input-output signal cable. Do not house them in the same bushing or tie them together.
- ◆ Do not use the same power supply with a welding machine or electro spark machine.
- ◆ When there is a high frequency generating device nearby, an EMI filter shall be connected to the input side of the main circuit cable.
- ◆ Ensure the earthing is appropriate.

### 2.3.1 Installation of EMI filter

In order to ensure the EMI filter can fully suppress the interference, please note:

Item	Reference
1	Servo drives and EMI filters must be installed on the same metal surface.
2	The wiring has to be as short as possible.
3	The metal surface shall be well grounded.
4	The metal housing or earthing of both servo drive and EMI filter shall be reliably fixed to the metal surface, with the contact area as big as possible.
5	The motor power line shall have shielded (double shielding layer is preferred).
6	Ground shielding copper with the shortest distance and maximum contact.

### 2.3.2 Connection of AC/DC reactor for suppression of higher harmonic

An AC/DC reactor can be connected to the servo drive for suppression of higher harmonic. Please connect the reactor according to the figure below:

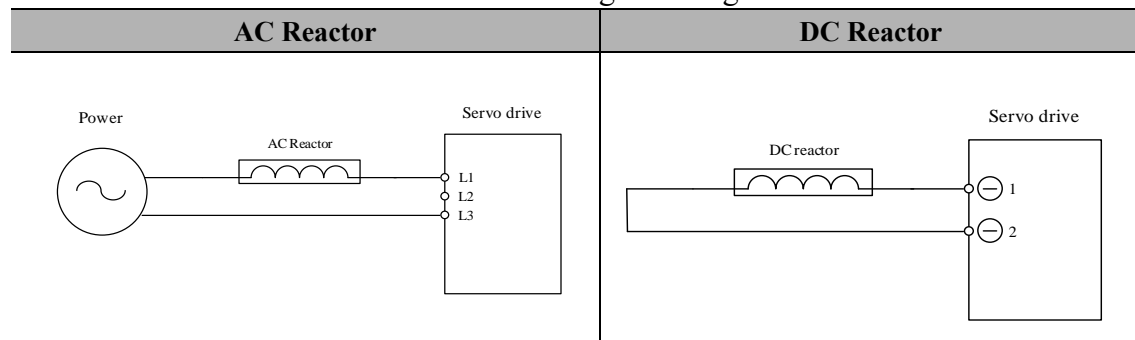

## 2.4 Selection of regenerative resistors

When the motor is outputting torque opposite to the rotating direction, energy is regenerated from the load to the drive. DC bus voltage will rise and at a certain level, the regenerated energy can only be consumed by the regenerative resistor. The drive contains an internal regenerative resistor, and users can also connect an external regenerative resistor. The table below shows the specifications of regenerative resistor contained in EPS-B2 series servo drives.

Servo drive case type	Internal regenerative resistor specs		Minimum allowable resistance value (Ohm)
	Resistance (Ohm)	Capacity (Watt)	
A	-	-	30
B	30 (220V)	60	20
C	30 (220V) \40 (380V)	80	13 (220V) \30 (380V)

When the regenerative capacity exceeds the disposable capacity of the internal regenerative resistor, an external regenerative resistor shall be connected. Please note:

Item	Reference
1	Please set the external resistor value and capacity correctly.
2	The external resistance value shall not be smaller than the minimum allowable resistance value. If parallel connection is to be used to increase the power, please confirm whether the resistance value satisfies the limiting conditions.
3	In natural environment, when the disposable regenerated capacity (mean value) of regenerative resistor is used within the limit of nominal capacity, the temperature of resistor will rise to be above 120°C (under continual regeneration). In order to ensure safety, it is suggested to use a regenerative resistor with a thermo-switch.
4	When external regenerative resistor is used, the resistor shall be connected to P, C end, and P, D end shall be open. External regenerative resistor shall follow the resistance value suggested in the table above.

# Chapter 3 Wirings

## 3.1 System structure and wiring

### 3.1.1 Servo system structure

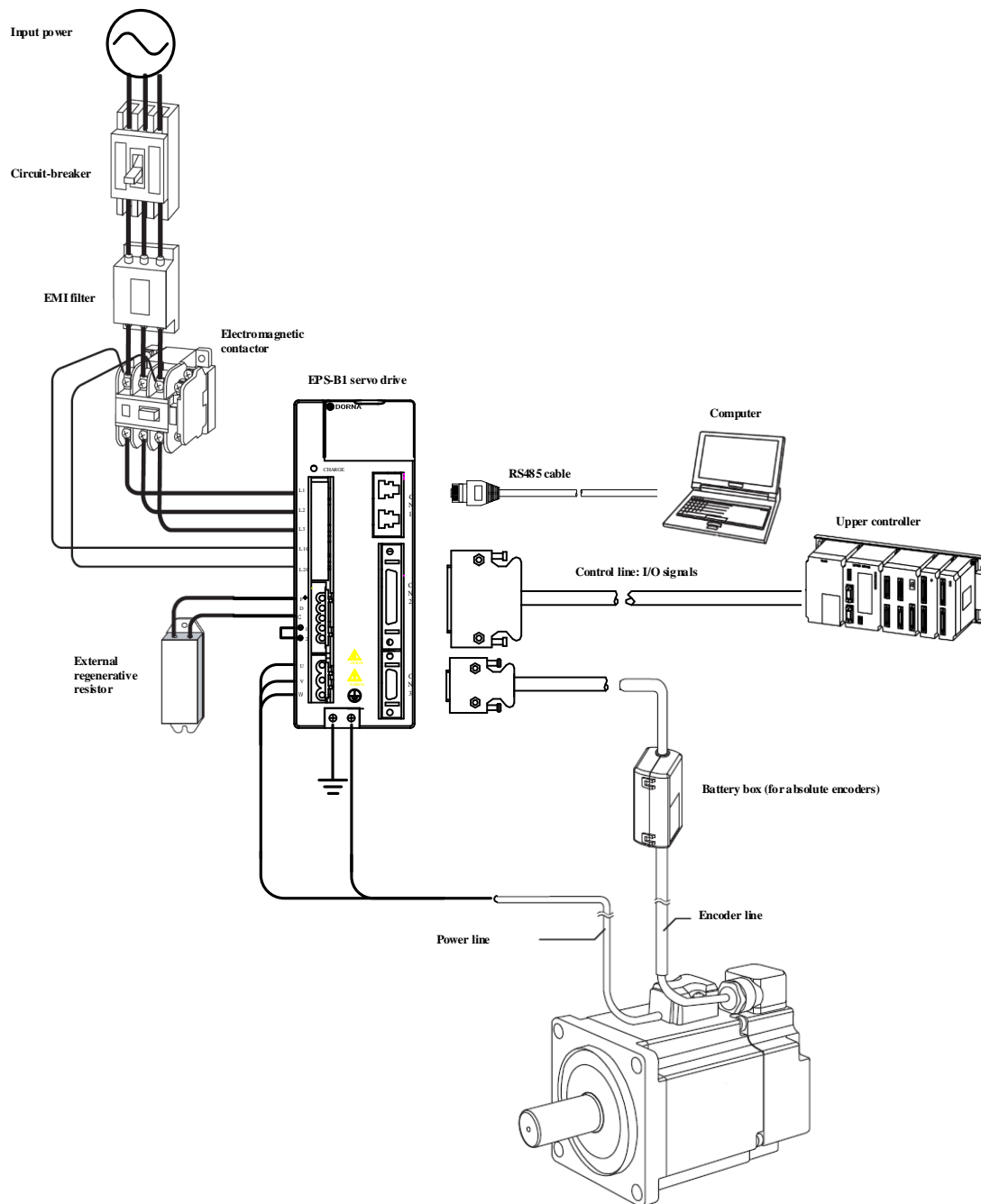

### 3.1.2 Servo drive connectors & terminals

Markings	Descriptions	Reference
L1, L2, L3	Main circuit input power terminals	Connect to 1/3 PH AC power supply. (Please choose correctly)
L1C, L2C	Control circuit input power terminals	Connect 1PH AC power supply. (Please choose correctly)
P, D, C	Regenerative resistor terminals	<ul style="list-style-type: none"> <li>Internal regenerative resistor: make PD short circuit, PC open.</li> <li>External regenerative resistor: connect PC to external resistor, PD open.</li> </ul>
⊖1, ⊖2	DC Reactor terminals	Connect ⊖1 & ⊖2 to DC reactor.
U, V, W	Servo motor power supply terminals	Connect with the servo motor
	Earth terminal	Connect with input power supply & motor power supply earth terminals for grounding.
CN1	RJ45 jack	RS-485 communication
CN2	I/O connector	Connect with upper controller
CN3	Encoder connector	Connect with the motor encoder

### 3.1.3 Main circuit wirings

#### 1) Cable diameter requirement

Mark	Name	Cable diameter: mm <sup>2</sup> (AWG)				
		EPS-B1-				
		0D20A	0D40A	0D75A	0001A	01D5A
L1, L2, L3	Main circuit input power terminals	1.25 (AWG-16)		2.0 (AWG-14)		
L1C, L2C	Control circuit input power terminals	1.25 (AWG-16)				
U, V, W	Servo motor power supply terminals	1.25 (AWG-16)		2.0 (AWG-14)		
P, D, C	Regenerative resistor terminals	1.25 (AWG-16)				
	Earth wire	Above 2.0 (AWG-14)				

#### 2) Typical main circuit wiring example

- When the signal of ALM is active, power supply of the main circuit shall be OFF.
- Main circuit & control circuit shall be powered on at the same time, or the control circuit first.
- The main circuit shall be powered off before the control circuit.

▪ **1PH 220VAC:**

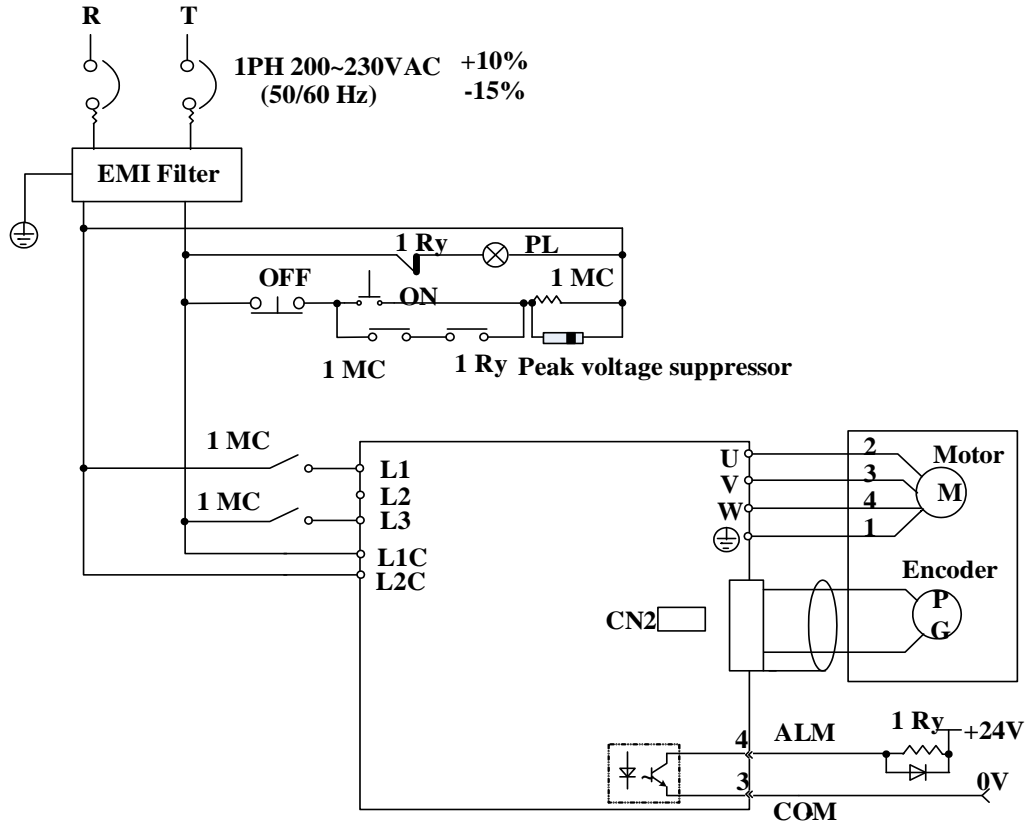

▪ **3PH 220VAC/380VAC:**

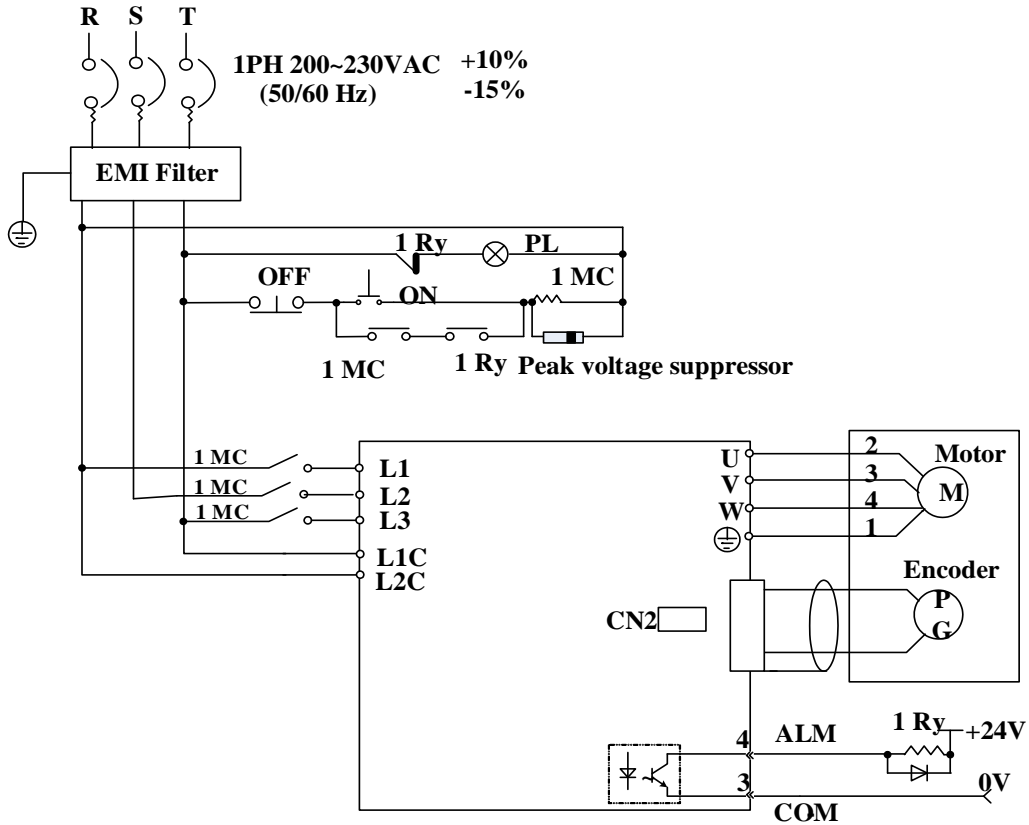

## 3.2 Wirings between servo drive & servo motor

### 3.2.1 Configurations & definitions of quick plug terminals

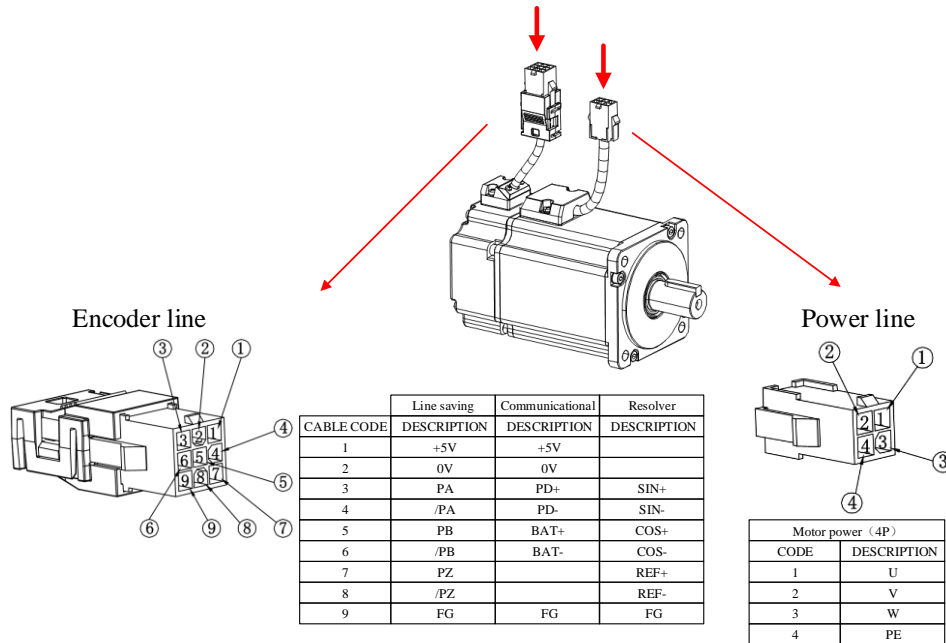

### 3.2.2 Configurations and definitions of aviation plug terminals

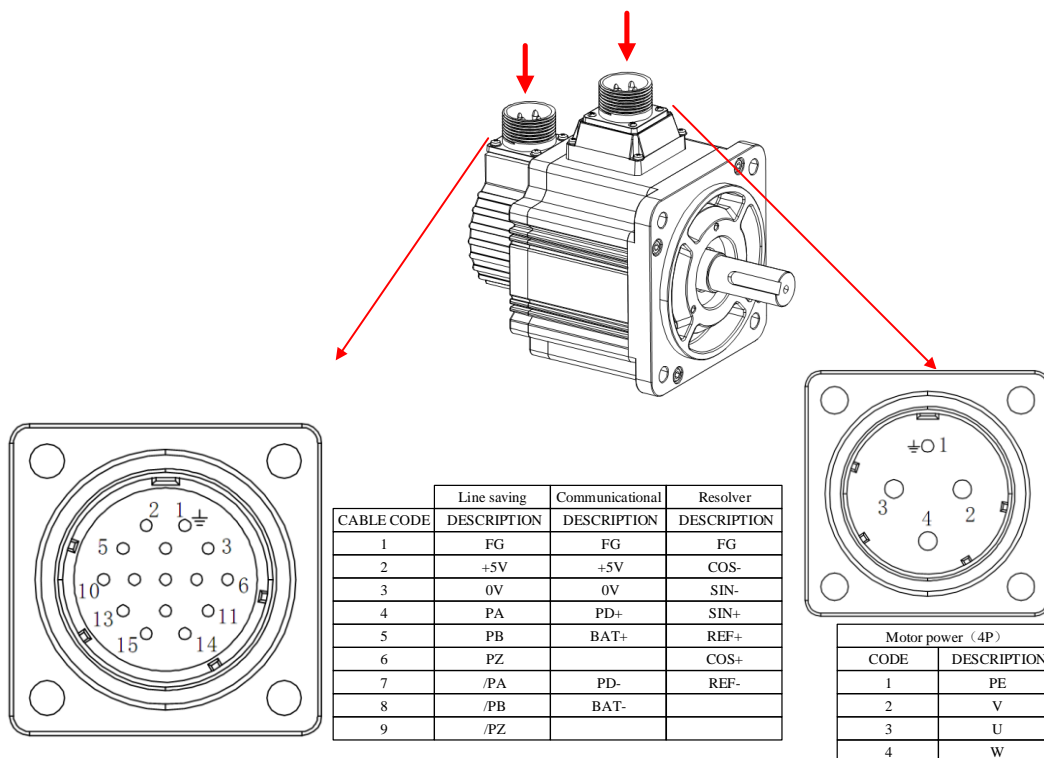



### 3.3 Wirings of CN1 (RS485 communication)

#### 1) Terminal appearance

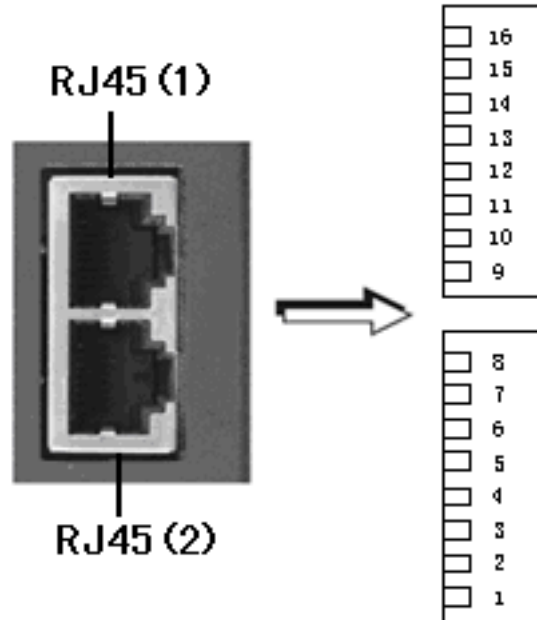

#### 2) Signal definitions

Mark	Name	Function
1, 9	RS485+	RS485+ Signal
2, 10	RS485-	RS485- Signal
3, 11	GND	Ground
4, 12	NC	-
5, 13	NC	-
6, 14	GND	Ground
7, 15	CANH	-
8, 16	CANL	-
Housing	FG	Shielding

### 3.4 Wirings of CN2 (I/O signals)

#### 3.4.1 Pin arrangement of CN2 connector

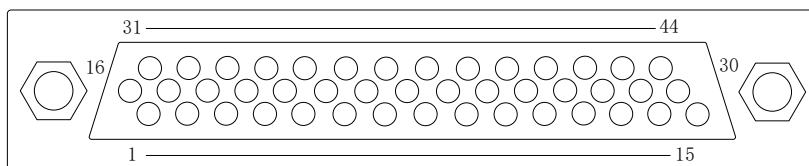

1	DO4+	Digital Output 4 (+)				31	DI7	Digital Input 7
2	DO3-	Digital Output 3 (-)	16	SG	GND	32	DI6	Digital Input 6
3	DO3+	Digital Output 3 (+)	17	+24V	24V Output (+)	33	DI5	Digital Input 5
4	DO2-	Digital Output 2 (-)	18	T-REF	Torque instruction Input (+)	34	DI3	Digital Input 3
5	DO2+	Digital Output 2 (+)	19	AGND	Torque instruction Input (-)	35	PL	Open collector power input
6	DO1-	Digital Output 1 (-)	20	V-REF	Speed instruction Input (+)	36	/HPULS	High speed pulse Input (-)
7	DO1+	Digital Output 1 (+)	21	PAO	Encoder output A+	37	/SIGN	Sign Input (-)
8	DI4	Digital Input 4	22	/PAO	Encoder output A-	38	HPULS	High speed pulse Input (+)
9	DI1	Digital Input 1	23	/PBO	Encoder output B-	39	SIGN	Sign Input (+)
10	DI2	Digital Input 2	24	/PZO	Encoder output Z-	40	/HSIGN	High speed pulse Input (-)
11	COM+	External 24V Input	25	PBO	Encoder output B+	41	/PULS	Pulse input (-)
12			26	DO4-	Digital Output4 (-)	42	HSIGN	High speed sign Input (+)
13	PZO	Encoder output Z+	27			43	PULS	Pulse input (+)
14	24V-GND	24V Output (-)	28			44	MON	Analog output
15			29	AGND	Speed instruction Input (-)			
			30	DI8	Digital Input 8			

Notes:

- 1) do not use vacant terminals.
- 2) Connect the shielding of control line (I/O cable) to the connector housing to achieve FG (frame grounding)
- 3) except for the CN2-6/7, all input and output pins can change signal allocations by parameters.
- 4) Maximum output current of internal 24V is 300mA. If internal 24V is used, internal 5V will lose power very quickly. Therefore, after editing parameters, saving has to be done in a special way. (First set PA006=0000, the edit the parameters, then set PA006=0080, PA006 will change to 0100 automatically).

### 3.4.2 CN2 signal descriptions

■ Name and function of input signals (with default pin allocations)

Mode	Signal	Pin No.	Function	
Universal	S-ON	9	Servo ON: The motor is powered on.	
	C-MOD	10	Control mode switch: Switch between two control modes.	
	POT	34	Forward rotation prohibited	Overtravel prohibited: Stop operation of servo motor when it is on.
	NOT	8	Reverse rotation prohibited	
	CLR	33	Clear position deviation pulses counter during position control.	
	A-RESTART	32	Reset alarms	
	INHIBIT	31	Pulse input inhibited	
	ZEROSPD	30	Zero-speed clamp signal input	
	COM+	11	External 24VDC for I/O signals	
Position control	HPULS+	38	High-speed channel pulse input	
	HPULS-	36		
	HSIGN+	42	* CCW+CW Pulse train	
	HSIGN-	40	* A + B Pulse train	
	PULS+	43	Low-speed channel pulse input level:	
	PULS-	41	* Sign+pulse train	
	SIGN+	39	* CCW+CW Pulse train	
	SIGN-	37	* A + B Pulse train	
	PL	35	Open collector pulse signal terminal	
Speed control	V-REF	20	Speed instruction voltage input	
	AGND	29		
Torque control	T-REF	18	Torque instruction voltage input	
	AGND	19		

■ Name and function of output signals (with default pin allocations)

Mode	Signal	Pin No.	Function	
Universal	PAO+	21	A phase signal	Two-phase pulse (A phase and B phase) encoder frequency dividing signal output
	PAO-	22		
	PBO+	25	B phase signal	
	PBO-	23		
	PZO+	13	Z phase signal	Original point (Z phase) signal output
	PZO-	24		
	ALM+	7	Servo alarm: <b>OFF when abnormal state is detected.</b>	
	ALM-	6		
	COIN+	5	Positioning completed: Under position control mode, when deviation pulse is smaller than PA525, the signal is active.	
	COIN-	4		
	CZ+	3	Optocoupler Z phase pulse output	
	CZ-	2		
	BK+	1	External brake signal output	
	BK -	26		
	MON	44	Speed or torque analog output. Voltage range $\pm 8V$ .	
SG	16			

### 3.4.3 Allocation of I/O signals

#### 1) Allocation of input signals

- Default input signal allocations

PA	Description	Range	Unit	Default	Effective
<b>PA500</b>	<b>DI 1 input signal selection</b>	0~30		0	Immediate
	[0] Servo-on (S-ON)				
	[1] Control mode switch (C-MODE)				
	[2] Forward rotation prohibited (POT)				
	[3] Reverse rotation prohibited (NOT)				
	[4] Deviation counter clearance (CLR)				
	[5] Alarm reset (A-RESTART)				
	[6] Pulse input inhibited (INHIBIT)				
	[7] Zero-speed clamp (ZEROSPD)				
	[8] Forward torque limitation (PCL)				
	[9] Reverse torque limitation (NCL)				
	[10] Gain switch (GAIN)				
	[11] Zero switch signal (ZPS)				
	[12] Negation signal for internal position control & internal speed control (CMDINV)				
	[13] Instruction division/ multiplication switch 0 (DIV0)				
	[14] Instruction division/ multiplication switch 1 (DIV1)				
	[15] Internal speed register 0 (INSPD0)				
	[16] Internal speed register 1 (INSPD1)				
	[17] Internal speed register 2 (INSPD2)				
	[18] Internal position register 0 (INPOS0)				
	[19] Internal position register 1 (INPOS1)				
	[20] Internal position register 2 (INPOS2)				
	[21] Internal position register 3 (INPOS3)				
	[22] Internal position control trigger (PTRG)				
	[23] Internal position control Forward JOG (P-POS)				
	[24] Internal position control Reverse JOG (N-POS)				
	[25] Internal position control homing start (SHOME)				
	[26] Internal position control stop (PZERO)				
	[28] Internal torque register 0 (INTor0)				
	[29] Internal torque register 1 (INTor1)				
	[30] Incremental/Absolute mode selection in internal position control mode (PAbs)				

<b>PA501</b>	DI 2 input signal selection	0~30		1	Immediate
<b>PA502</b>	DI 3 input signal selection	0~30		2	Immediate
<b>PA503</b>	DI 4 input signal selection	0~30		3	Immediate
<b>PA504</b>	DI 5 input signal selection	0~30		4	Immediate
<b>PA505</b>	DI 6 input signal selection	0~30		5	Immediate
<b>PA506</b>	DI 7 input signal selection	0~30		6	Immediate
<b>PA507</b>	DI 8 input signal selection	0~30		7	Immediate

- Default signals and corresponding pins of DI 1~ DI 8:

<b>Parameter No.</b>	<b>Terminal name</b>	<b>CN2 pin</b>	<b>Default signal</b>
PA500	DI 1	9	S-ON
PA501	DI 2	10	C-MOD
PA502	DI 3	34	POT
PA503	DI 4	8	NOT
PA504	DI 5	33	CLR
PA505	DI 6	32	A-RESTART
PA506	DI 7	31	INHIBIT
PA507	DI 8	30	ZEROSPD

- Level selection of input signals

PA	Description	Range	Unit	Default	Effective
PA508	<p><b>Level selection of input signal 0</b></p> <p><b>b.0001: DI 1 input signal level selection;</b>            [0] L level active (optocoupler conductive)            [1] H level active (optocoupler not conductive)</p> <p><b>b.0010: DI 2 input signal level selection;</b>            [0] L level active (optocoupler conductive)            [1] H level active (optocoupler not conductive)</p> <p><b>b.0100: DI 3 input signal level selection;</b>            [0] L level active (optocoupler conductive)            [1] H level active (optocoupler not conductive)</p> <p><b>b. 1000: DI 4 input signal level selection;</b>            [0] L level active (optocoupler conductive)            [1] H level active (optocoupler not conductive)</p>	b.0000 ~1111		b.0000	Immediate
PA509	<p><b>Level selection of input signal 1</b></p> <p><b>b.0001: DI 5 input signal level selection;</b>            [0] L level active (optocoupler conductive)            [1] H level active (optocoupler not conductive)</p> <p><b>b.0010: DI 6 input signal level selection;</b>            [0] L level active (optocoupler conductive)            [1] H level active (optocoupler not conductive)</p> <p><b>b.0100: DI 7 input signal level selection;</b>            [0] L level active (optocoupler conductive)            [1] H level active (optocoupler not conductive)</p> <p><b>b. 1000: DI 8 input signal level selection;</b>            [0] L level active (optocoupler conductive)            [1] H level active (optocoupler not conductive)</p>	b.0000 ~1111		b.0000	Immediate

- Change level selection of input signals

When signals like S-ON, POT, NOT are used through "polarity inversion", if there are abnormal states like breakage of signal line, it will cause movement deviating from the safety direction. If such setting has to be adopted, please confirm the action and ensure there are no safety problems.

The typical circuit of input signal is as follows:

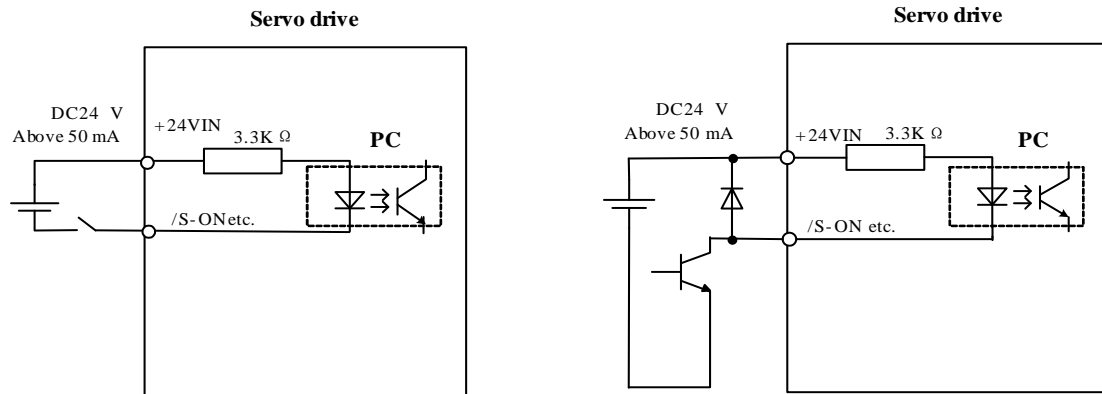

Take the above figure as an example. When the optocoupler is conductive, S-ON signal is L level; when the optocoupler is not conductive, S-ON signal is H level. Parameter PA508 decides the active level of S-ON. When PA508.0=0, S-ON signal is L level active; when PA508.0=1, S-ON signal is H level active.

- Confirmation of input signal level selections

The level selection of the input signal can be confirmed by the input signal monitoring (dP012).

- Multiple pins with same signal allocation

If same signal has been allocated to multiple I/O pins, the highest grade pin prevails. For example, DI 0 and DI 1 are both set to 0 (S-ON), then S-ON is only determined by DI 1 (highest grade pin).



## 2) Allocation of output signals

- Default allocations of output signals

PA	Description	Range	Unit	Default	Effective
PA510	<p><b>Output signal selection</b></p> <p><b>h.0001: DO 1 output signal selection</b></p> <p>[0] Alarm signal output (ALM)</p> <p>[1] Positioning completed (COIN): active when position pulse deviation is less than PA525.</p> <p>[2] Z pulse open-collector signal (CZ): can be negated by PA003.3 and expanded by PA201.3 &amp; PA210.</p> <p>[3] Brake release signal (BK): can be adjusted by PA518.</p> <p>[4] Servo ready signal (S-RDY): active when servo is in proper status.</p> <p>[5] Speed instruction reached (VCMP) / (torque threshold): active when speed deviation is less than PA517.</p> <p>[6] Motor rotation detection (TGON): active when rotational speed exceeds PA516.</p> <p>[7] Torque limited signal (TLC): active when load torque reaches PA402/PA403.</p> <p>[8] Zero-speed detection signal (ZSP): active when rotational speed is less than PA515.</p> <p>[9] Warning output (WARN)</p> <p>[A] Internal position control homing completion signal (HOME)</p> <p>[B] Internal position control position instruction completion signal (CMD-OK)</p> <p>[C] Internal position control positioning &amp; command completion signal (MC-OK)</p> <p>[D] Torque reached (TREACH): active when forward load torque exceeds PA404 or reverse load torque exceeds PA405.</p> <p><b>h.0010: DO 2 output signal selection</b> same as DO 1</p> <p><b>h.0100: DO 3 output signal selection</b> same as DO 1</p> <p><b>h.1000: DO 4 output signal selection</b> same as DO 1</p>	h.0000 ~DDDD		h.3210	Immediate

PA511	<b>Output signal level selection (negation)</b> <b>b.0001: DO 1 (ALM) output signal level selection</b> [0] H level active (optocoupler not conductive) [1] L level active (optocoupler conductive) <b>b.0010: DO 2 output signal level selection</b> [0] L level active (optocoupler conductive) [1] H level active (optocoupler not conductive) <b>b.0100: DO 3 output signal level selection</b> [0] L level active (optocoupler conductive) [1] H level active (optocoupler not conductive) <b>b.1000: DO 4 output signal level selection</b> [0] L level active (optocoupler conductive) [1] H level active (optocoupler not conductive)	b.0000 ~1111		b.0000	Immediate

- Default signals and corresponding pins of DO 1 to DO 4

Parameter No.	Terminal name	CN2 pin	Default signal
PA510.0	DO1	7, 6	ALM
PA510.1	DO2	5, 4	COIN
PA510.2	DO3	3, 2	CZ
PA510.3	DO4	1, 26	BK

- Change level selection of output signals

If an output signal is not detected, then it is regarded as invalid. For example, COIN is invalid at speed control mode.

Typical output signal circuit is shown in the following diagram:

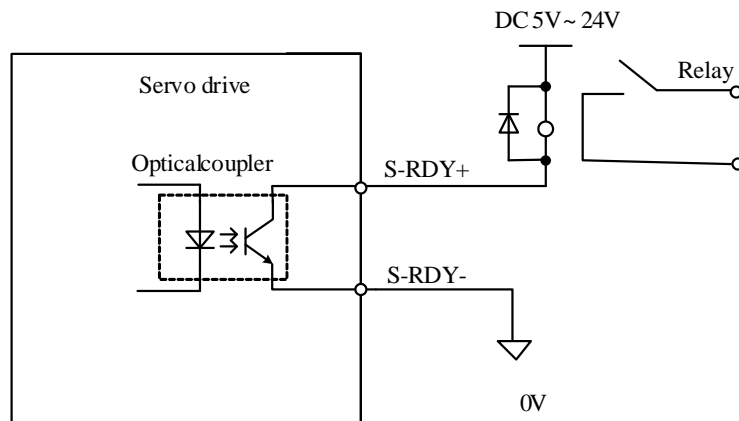

Maximum allowable voltage: DC 30V  
Maximum allowable current: DC 50mA

Take above figure as an example, COIN level is determined by PA510. When PA510=0, L level (conductive) is active; when PA510=1, H level (nonconductive) is active.

- Notes:
  - ALM, WARN: active means alarm; inactive means no alarm.
  - CZ level status cannot be modified by PA511;
  - If same signal has been allocated to multiple I/O pins, the highest grade pin prevails. For example, DO 2 and DO 3 are both set to 2 (CZ), then CZ is only determined by DO 3 (highest grade pin).

### 3.4.4 Examples of connection with upper controllers

#### 1) Input signal connections

- Line driver, low speed pulse

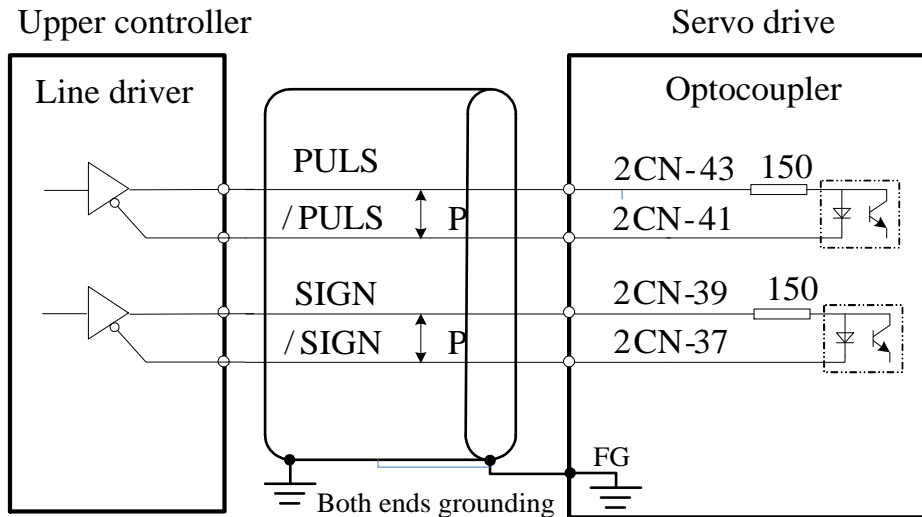

- Line driver, high speed pulse (**maximum voltage: 5VDC**)

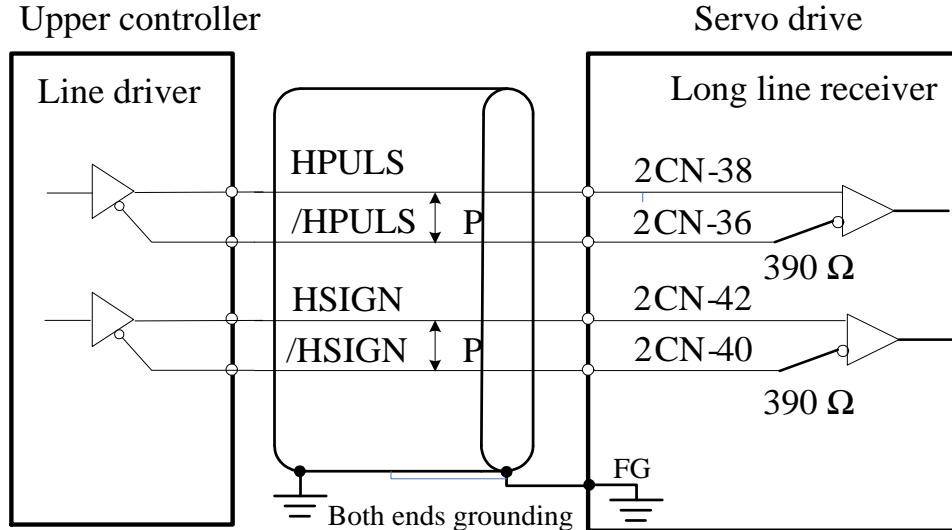

Compatible line driver: AM26LS31 (TI) or equivalent.

Connect the grounding of both controller & servo drive together in order to improve the anti-interference ability of the high speed pulse input interface.

- Open collector, option 1 (external 24VDC)

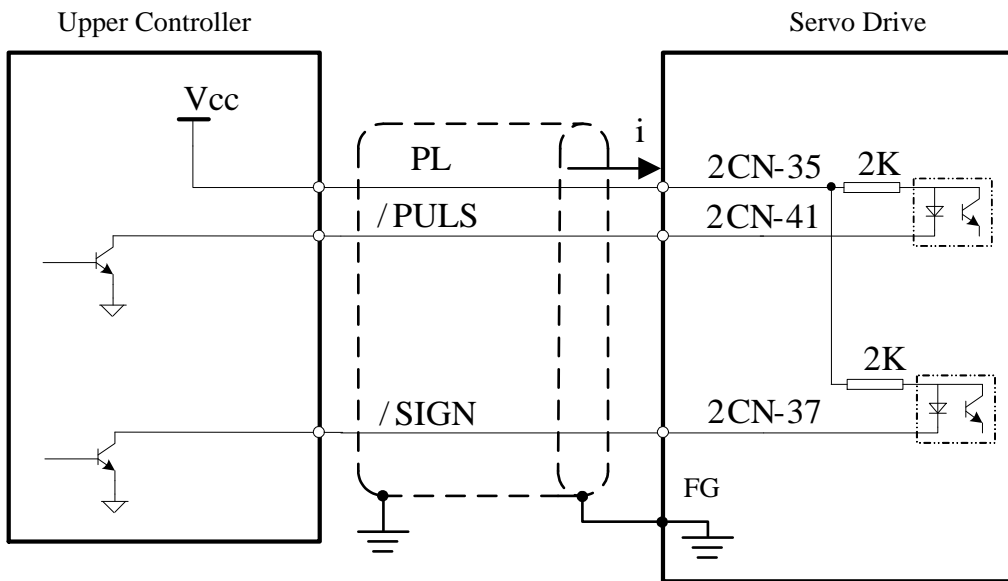

- Open collector, option 2 (external 5VDC, 12VDC or 24VDC)

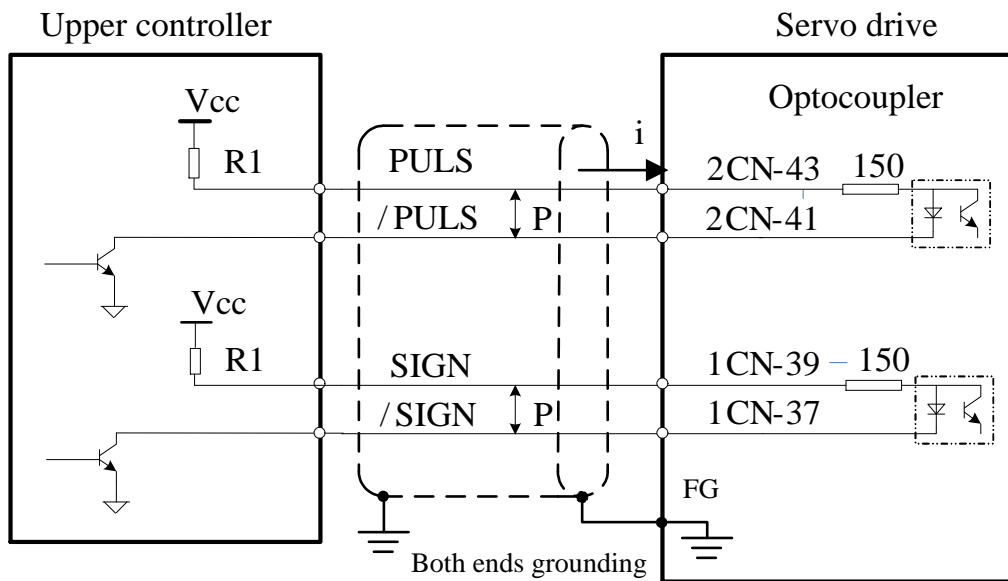

Input current  $I = 10 \sim 15\text{mA}$ , thus R1 resistance:

If 24VDC,  $R1=2\text{K } \Omega$ ;

If 12VDC,  $R1=510 \Omega$ ;

If 5VDC,  $R1=180 \Omega$ ;

Normally, open collector pulses can be easily interfered. To reduce interference:

- Grounding: control line shielding shall connect to ground of upper controller power supply; on the drive side, the shielding shall hang in air;
- Modify PA201.0: the higher PA201.0, the higher filtering effect, the lower input chop frequency.

- Analog input

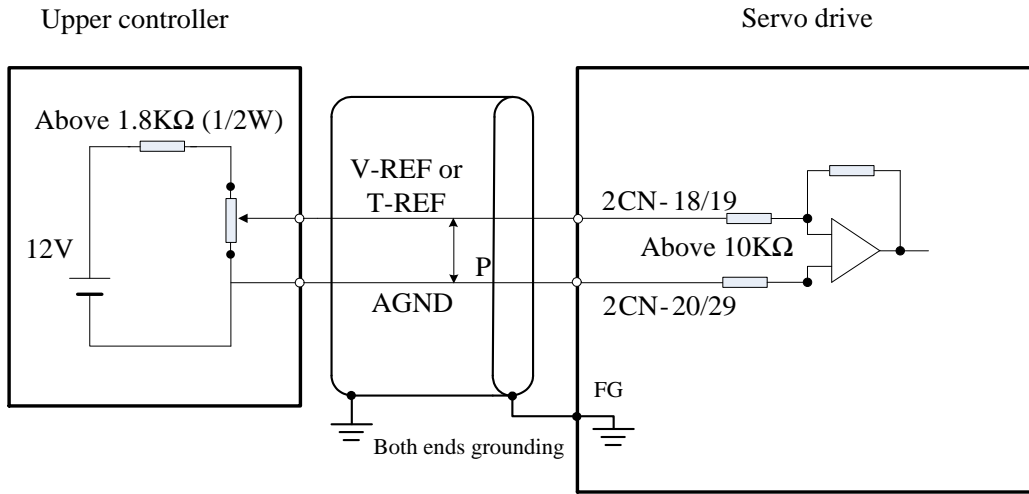

- Sequential control input

Connected by a relay or an open collector transistor circuit. When using relay connections, select the micro current relay. If you do not use small current relay, it will cause bad contact.

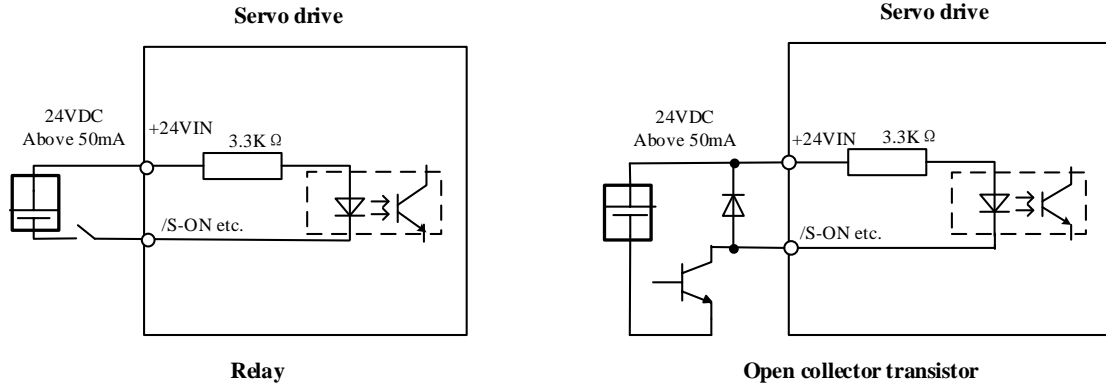

## 2) Output signal connections

- Sequential control output

ALM, S-RDY and other sequence of output signals are consisted of optocoupler. Please connect with relays.

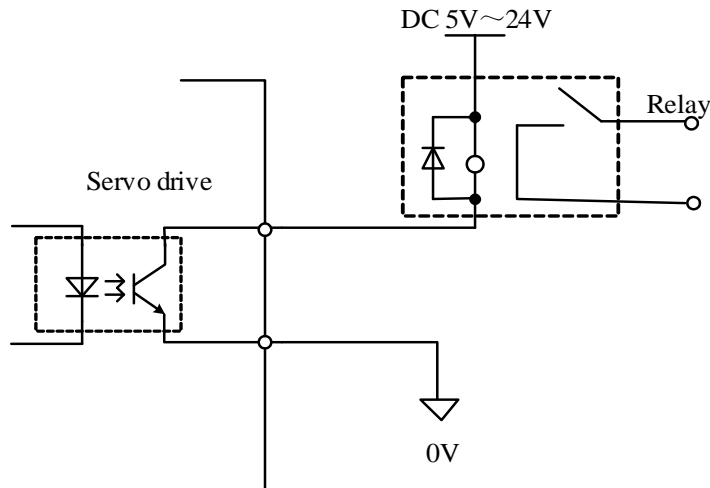

Maximum DC voltage: 30VDC  
Maximum DC current: 50mA

- Line driver output

Encoder serial data are inverted into differential signals. Please use line receiver to process the output signals: PAO, /PAO; PBO, /PBO; PZO, /PZO.

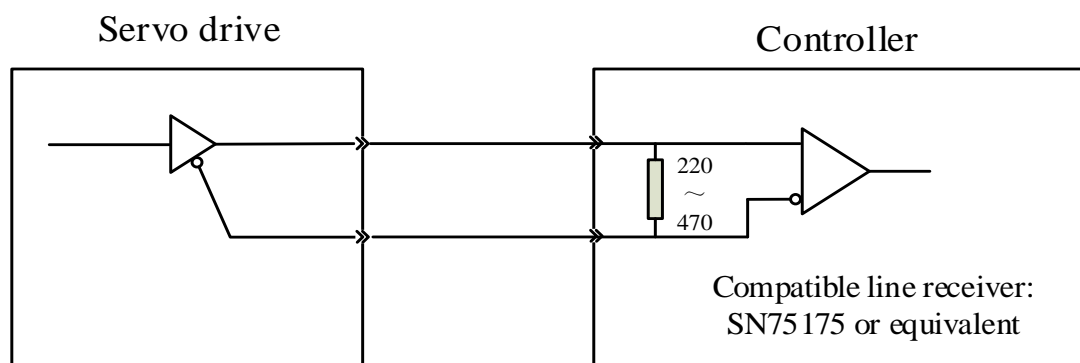

- Analog output

Pin 44 (MON) & Pin 16 (SG) can be used to provide monitored analog data. For example, motor speed & current can be presented by analog voltages. The servo drive provides one output channel for the user to monitor the data selected by PA021. This signal is referenced by GND and output voltage range is -8V~+8V.

### 3.5 Wirings of CN3 (feedback from encoder to servo drive)

#### 3.5.1 Pin arrangement of CN3 connector

##### 1) Quick plug

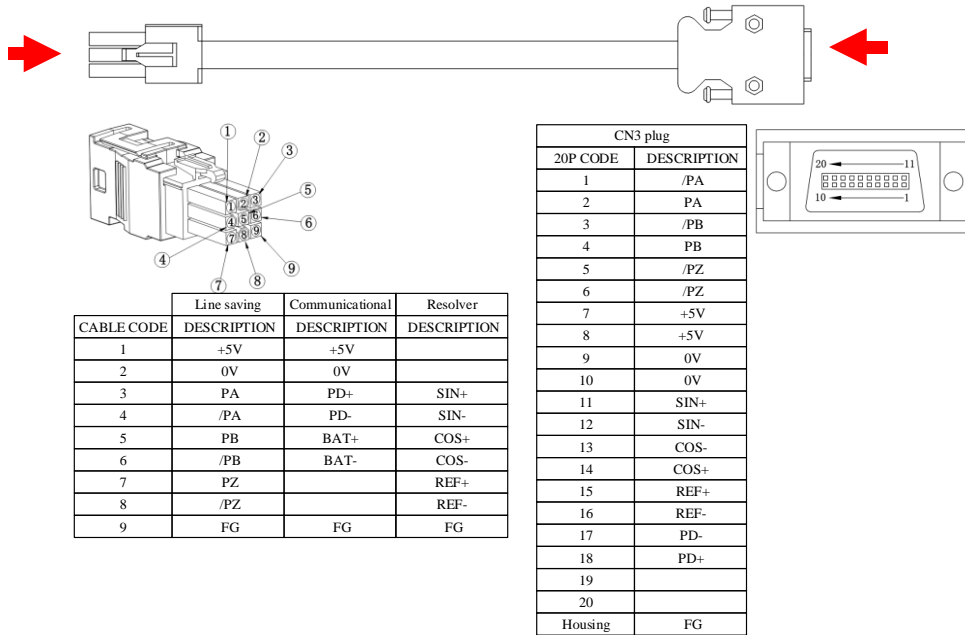

##### 2) Aviation plug

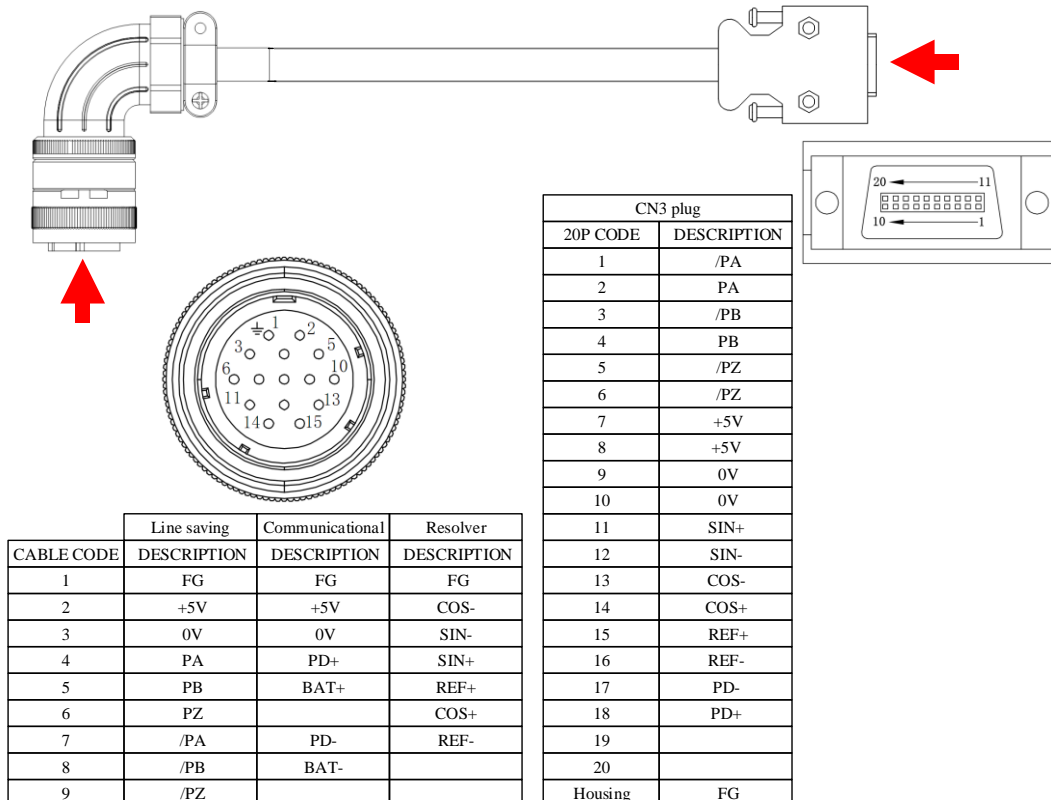



### 3.5.2 Examples of CN3 connections

#### ■ Line-saving incremental encoder

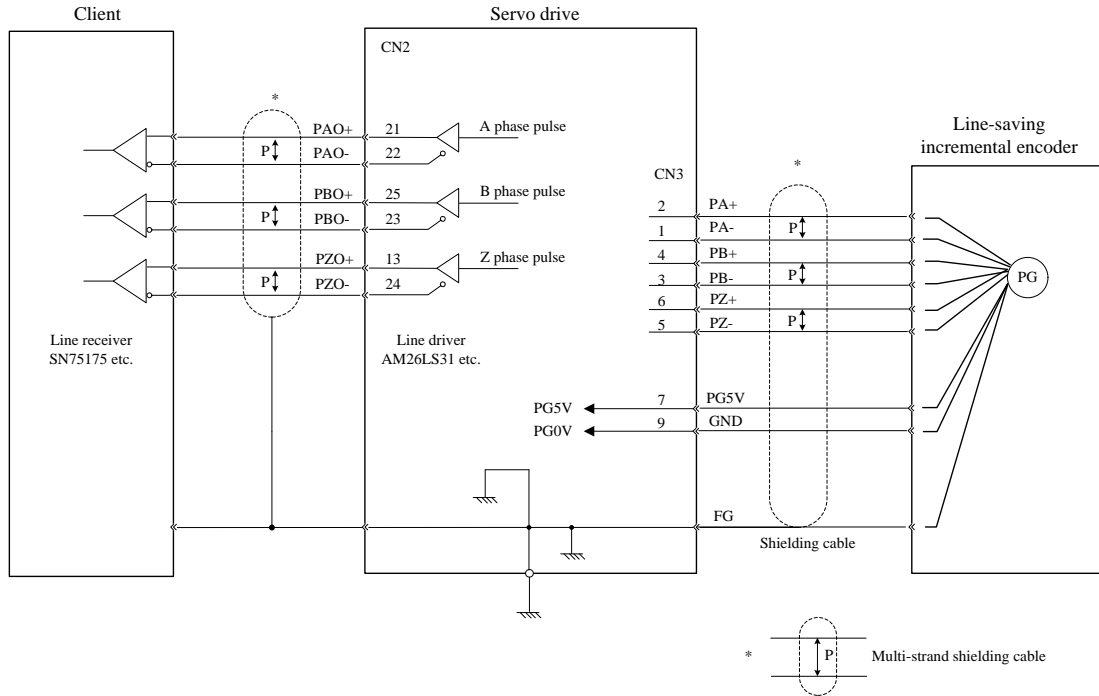

#### ■ 17-bit serial encoder

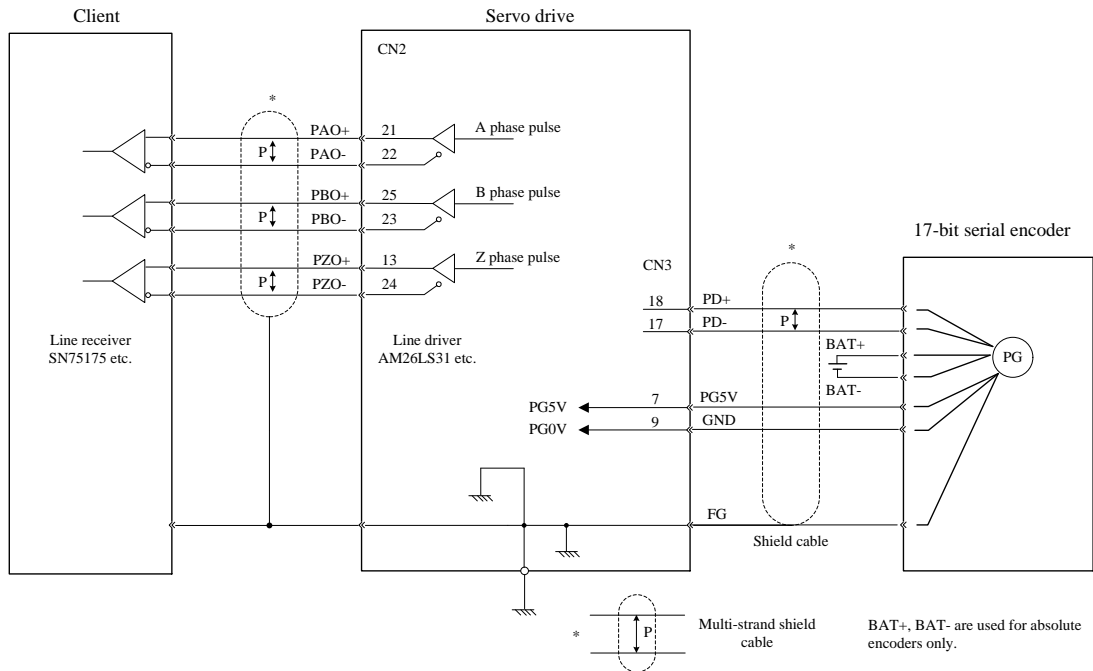

## 3.6 Standard wiring diagrams

### 3.6.1 Position control

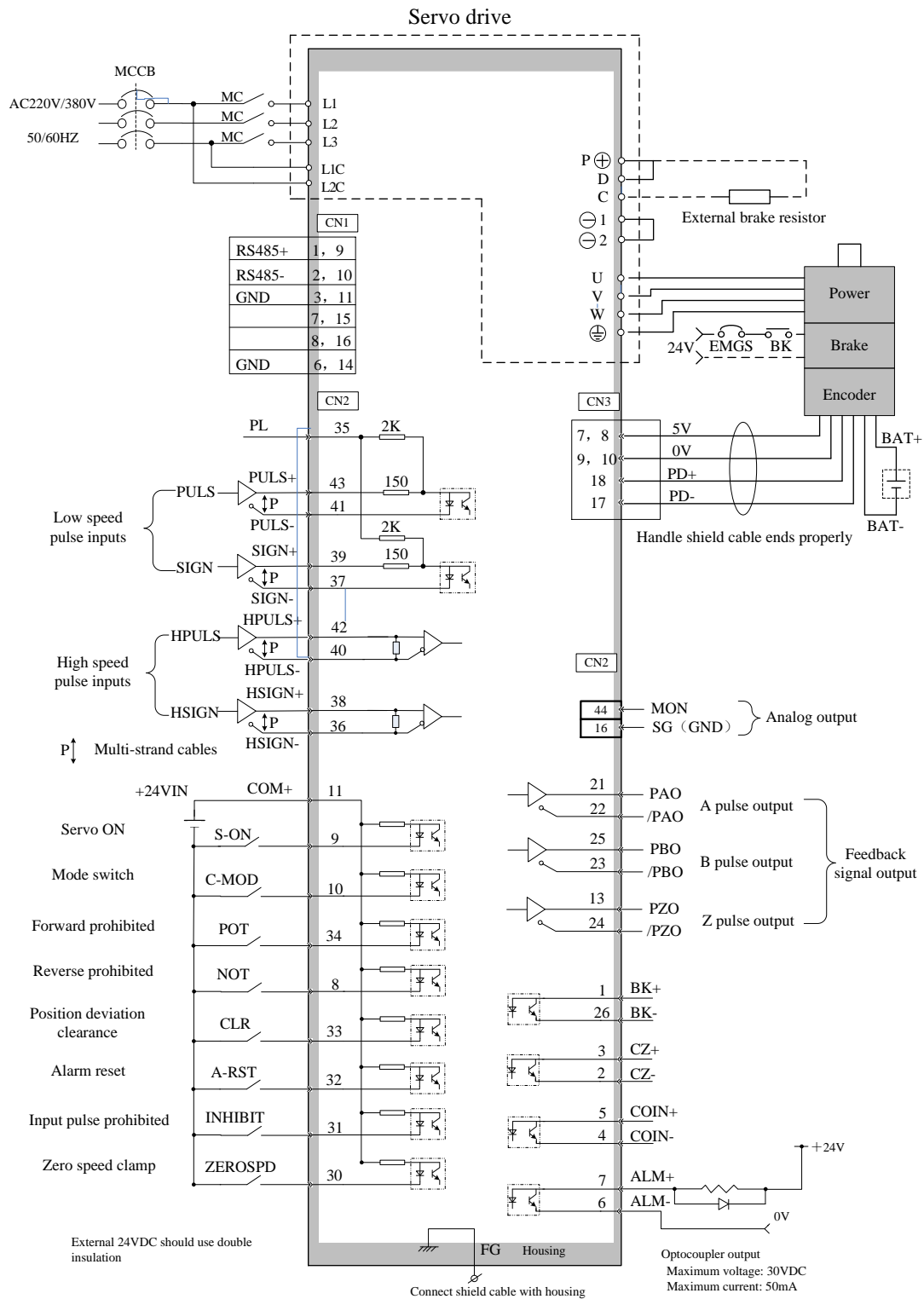

### 3.6.2 Speed/torque control

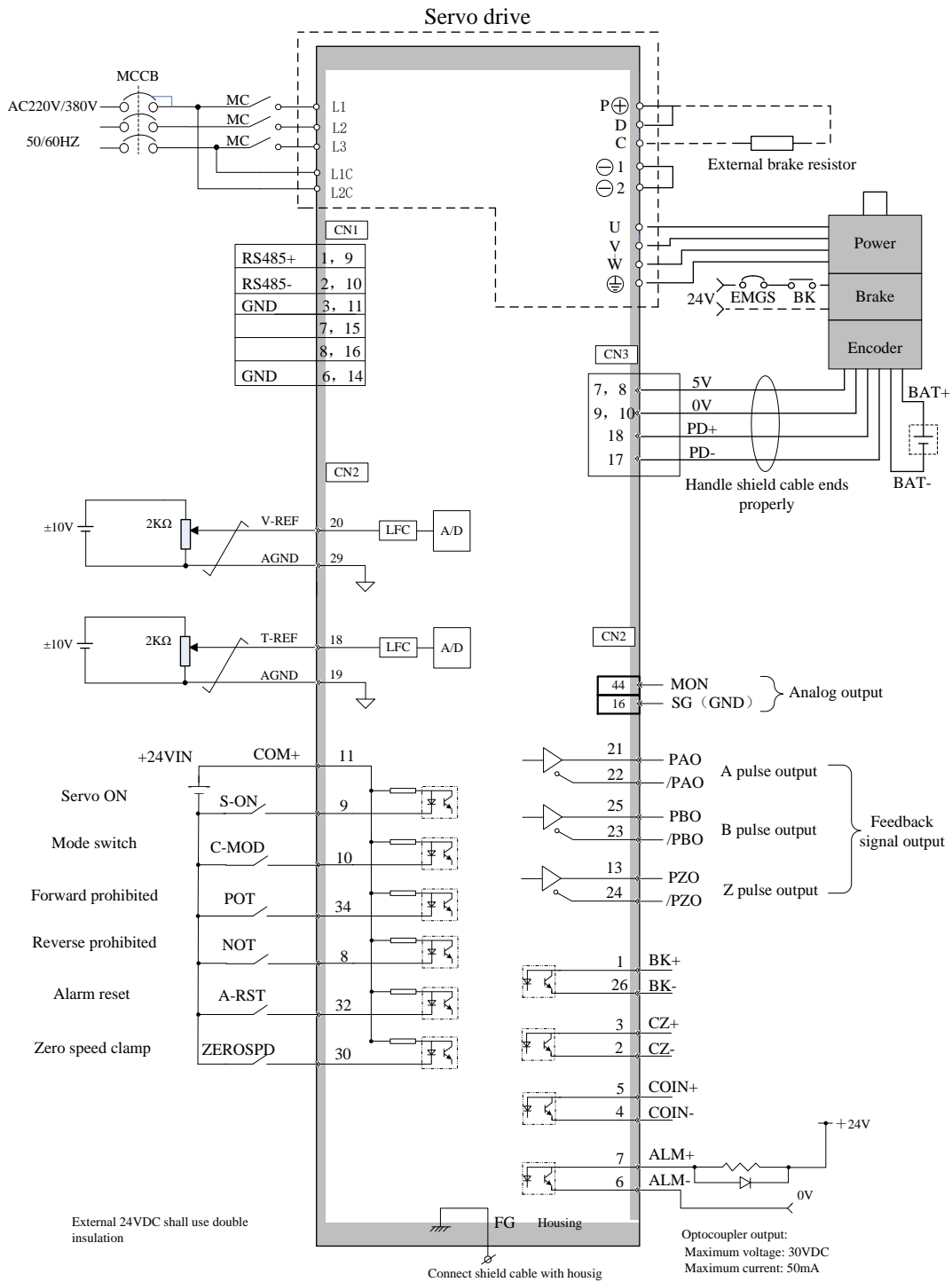

# Chapter 4 Panel operations

## 4.1 Panel operator

Panel operator consists of a panel display and operating keys. Panel operator is used for displaying status, performing auxiliary functions, setting parameters and monitoring servo drive's movements. **Hold & press ↑ & ← keys together can clear servo drive alarms. BUT please find out the cause of alarms first.**

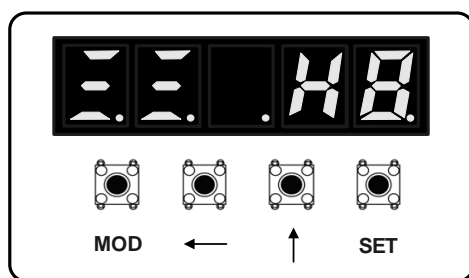

Key	Function description
MOD	Switch between different modes or cancel
←	Decimal point moves leftwards, in loops
↑	Increase or switches between + and-
SET	Equivalent to ENTER

## 4.2 Switch between different functions

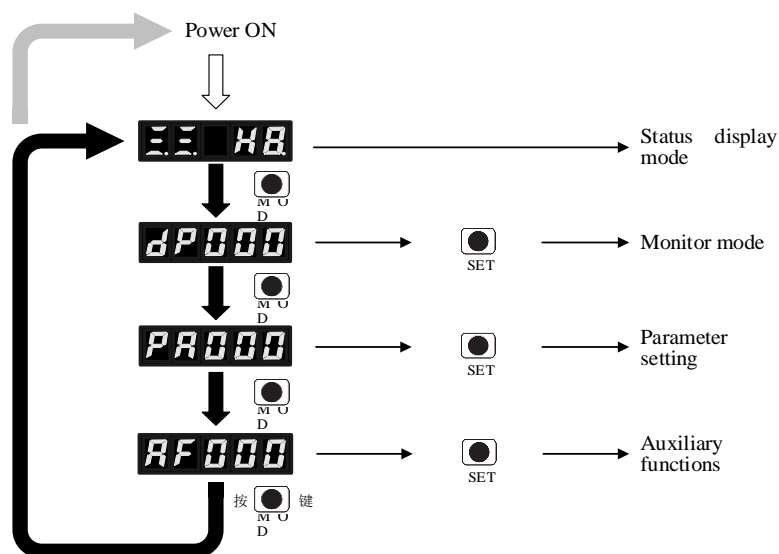





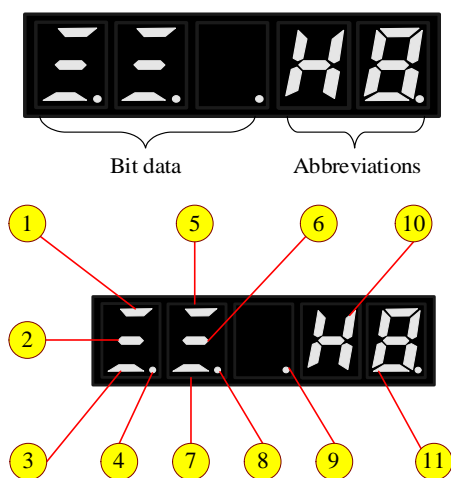





## 4.3 Status code display

Status of servo drive is displayed by digits.



Bit data			
No.	Definition	Description in position control mode	Description in speed, torque control mode
①	Power supply ready	On when the main circuit power is ON; Off when the main circuit power is OFF.	On when the main circuit power is ON; Off when the main circuit power is OFF.
②	Compatibility	Positioning completed (COIN)	Speed instruction reached (VCMP)
③	Clear input signals	On when there is CLR input. Off when there is no CLR input.	On when there is CLR input. Off when there is no CLR input.
④	Position control mode	Light on	Light off
⑤	Rotation detection	When speed exceeds the set speed, the light is on (TGON)	When speed exceeds the set speed, the light is on (TGON)
⑥	Instruction input	Pulse input in progress	Speed/torque control in progress
⑦	Torque detection	Torque instruction exceeds the set value (20% of nominal torque).	Torque instruction exceeds the set value (20% of nominal torque).
⑧	Speed control mode	Light off	Light on if speed control is in progress.
⑨	Torque control mode	Light off	Light on if torque control is in progress.

Abbreviations			
10	Limit	 : left limit.  : right limit  &  alternately: left & right limits	 : left limit.  : right limit  &  alternately: left & right limits
11	Run	 : motor is excited.	 : motor is excited.







## 4.4 Monitoring display mode (dP □□)

At monitoring display mode, user can monitor the set values, I/O signal status and internal status of the servo drive.

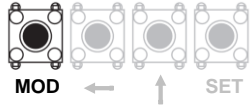
### 4.4.1 Contents of monitoring display mode

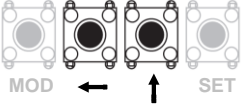
Please refer to Chapter 5.1.

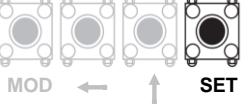
### 4.4.2 Example of operations at monitoring display mode (dP 00)

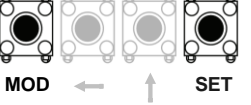



Steps	Panel display	Keys	Operations
1			Press MOD key to choose monitoring display function.
2			If the panel display is not dP 00, press UP & LEFT until it is dP 00.
3			Press SET to enter dP 00. This shows motor speed is 1600rpm.
4			Press SET or MOD to return to Step 1.
5	End of operations		

## 4.5 Parameter mode (PA □□□)





### 4.5.1 Remarks at parameter mode

#### ■ Storage setting status

After parameter editing, press SET to store the setting, and the panel display will constantly display the set state symbol for one second according to the setting state.

Panel display	Remarks
	Correct setting value, saved (Saved)
	Parameter effective after power off, then power on again (Reset)
	Wrong setting value or input data out of range (Out of Range)
	Parameter protected by cryptograph, cannot be modified (No operation)

#### ■ Data type

Panel display	Remarks
	Left-most digit is blank, meaning setting is on decimal base. When data is unsigned number, the setting range of left-most digit is 0~6, other digits are 0~9; When data is signed number, the left-most digit is the sign digit.
	The left-most digit is "b", meaning that the parameter setting is on a binary base. Scope for each digit is 0 ~ 1.
	The left-most digit is "d", meaning that the parameter setting is on a decimal base. Scope for each digit is 0 ~ 9.
	The left-most digit is "h", meaning that the parameter setting is on a hexadecimal base. Scope for each digit is 0 ~ F.

## 4.5.2 Example of operations at parameter mode (PA100)

Steps	Panel display	Keys	Operations
1			Press MOD to choose parameter mode.
2			If the panel display is not PA100, press ↑ & ← until it is PA100.
3			Press SET to enter the parameter editing interface; it will show the left figure which means the current number is 40.
4			Press “←” to make the digit 4 blink.
5			Press “↑” for 6 times and the value becomes “00”.
6			Press “←” to move the digit, as shown in the left figure.
7			Press “↑” for 2 times and the value becomes “200”.
8			Press SET to set the value of PA100 to 200. In this case, the value becomes effective immediately.
9			After about 1s, the display will return to the parameter editing interface.
10			Press MODE to exit
11	End of operations		



## 4.6 Auxiliary function mode (AF □□)

Auxiliary functions are used to perform some additional setting & tuning of the servo drive.

### 4.6.1 Contents of auxiliary function mode

Please refer to Chapter 6.1

### 4.6.2 Example of operations at auxiliary function mode (AF 05)

Steps	Panel display	Keys	Operations
1			Press MOD key to choose the auxiliary function.
2			Press “↑” or “←” to show “AF005”.
3			If the servo is not running, press SET and the panel will display the left figure.
			If the servo is running or the panel lock (AF 03) is set, the panel will display the left figure.
4			Press and hold “↑” to show the left figure.
5			Continue pressing it and the left figure means operation is completed.
6			Relieve the key and the panel displays the left figure.
7			Press MOD or SET to exit from the auxiliary function and return to the display in step 2.
8	End of operations		

# Chapter 5 Monitoring display parameters







## 5.1 List of monitoring display parameters

No.	Function	Unit
dP 00	<b>Motor speed</b> Display the motor operating speed	[rpm]
dP 01	<b>Motor feedback pulse number (encoder unit, lower 4 digits)</b> Display the lower 4 digits of the sum of motor encoder feedback pulse.	[1 encoder pulse]
dP 02	<b>Motor feedback pulse number (encoder unit, higher 5 digits)</b> Display the higher 5 digits of the sum of motor encoder feedback pulse.	[10 <sup>4</sup> encoder pulses]
dP 03	<b>Input pulse number before electronic gear (user unit, lower 4 digits)</b> Lower 4 digits of the sum of input pulse number in position control mode.	[1 input pulse]
dP 04	<b>Input pulse number before electronic gear (user unit, higher 5 digits)</b> Higher 5 digits of the sum of input pulse number in position control mode.	[[10 <sup>4</sup> input pulses]
dP 05	<b>Deviation pulse number (encoder unit, lower 4 digits)</b> Lower 4 digits of the sum of deviation pulse number in position control mode.	[1 encoder pulse]
dP 06	<b>Deviation pulse number (encoder unit, higher 5 digits)</b> Higher 5 digits of the sum of deviation pulse number in position control mode.	[10 <sup>4</sup> encoder pulses]
dP 07	<b>Speed instruction (analog voltage instruction)</b> Voltage value of analog input in speed control mode, after correction of null shift. When the voltage exceeds ±10V, it cannot be displayed correctly.	[0.1V]
dP 08	<b>Internal speed instruction</b> Internal speed instruction under speed control and position control.	[r/min]
dP 09	<b>Torque instruction (analog voltage instruction)</b> Voltage value of analog input in torque control mode, after correction of null shift. When the voltage exceeds ±10V, it cannot be displayed correctly.	[0.1V]
dP 10	<b>Internal torque instruction (value in relation to the rated torque)</b> Internal torque instruction in torque / speed / position control modes.	[%]

<b>dP 11</b>	<b>Torque feedback (value in relation to the rated torque)</b> Torque feedback value in torque / speed / position control modes.	[%]
<b>dP 12</b>	<b>Input signal monitoring</b> Input signal status of CN2 connector	-
<b>dP 13</b>	<b>Output signal monitoring</b> Output signal status of CN2 connector	-
<b>dP 14</b>	<b>Instruction pulse frequency</b> Instruction pulse frequency of the upper controller in position control.	[0.1Khz]
<b>dP 15</b>	<b>DC bus voltage</b> DC bus voltage after rectification	[V]
<b>dP 16</b>	<b>Total operation time of the servo drive</b> If AF05 operation is implemented, the value will be reset.	[Hours]
<b>dP 17</b>	<b>Rotation angle</b> Display the electric rotational angle of the motor.	[deg]
<b>dP 18</b>	<b>Exact position of absolute encoder (single-turn or multi-turn)</b> This displays the absolute position data of the encoder in one turn.	[2 Encoder pulse]
<b>dP 19</b>	<b>Number of encoder turns (only for multi-turn absolute encoders)</b> This displays the number of turns of multi-turn absolute encoder.	[1 turn]
<b>dP 20</b>	<b>Cumulative load factor (take rated cumulative load as 100%)</b> Alarm grade during motor overload protection.	[%]
<b>dP 21</b>	<b>Regeneration load factor (take rated regeneration load as 100%)</b> Alarm grade during regeneration overload protection	[%]
<b>dP 22</b>	<b>DB load factor (take rated DB load as 100%)</b> Alarm grade during DB braking protection	[%]
<b>dP 23</b>	<b>Load inertial ratio</b> Display the ratio between load inertia and motor inertia.	[%]
<b>dP 24</b>	<b>Effective gain monitoring</b> 1: the first group of gains is effective 2: the second group of gains is effective	-
<b>dP 30</b>	<b>Subsidiary software version (refer to AF 10 for main software version)</b>	-
<b>dP 34</b>	External linear encoder feedback pulse counts low place	[1 encoder pulse]
<b>dP 35</b>	External linear encoder feedback pulse counts high place	[10 <sup>4</sup> encoder pulses]
<b>dP 38</b>	Hybrid deviation low place	[1 encoder pulse]
<b>dP 39</b>	Hybrid deviation high place	[10 <sup>4</sup> encoder pulses]
<b>dP 40</b>	<b>Voltage class (refer to PA000.3 for voltage class setting)</b>	-
<b>dP 46</b>	<b>IGBT temperature</b>	°C

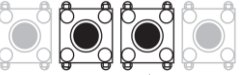
## 5.2 Input signal monitoring (dP 12)

### 5.2.1 Operations of entering dP 12

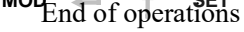
Steps	Panel display	Keys	Operations
1			Press MOD key to choose monitoring display function.
2			If the panel display is not dP 12, press ↑ & ← until it is dP 12.
3			Press SET to enter dP 12.
4			Press SET or MOD to exit to Step 1.
5			

### 5.2.2 Explanations of dP 12 LED displays

Input signal status are shown by the LED displays.

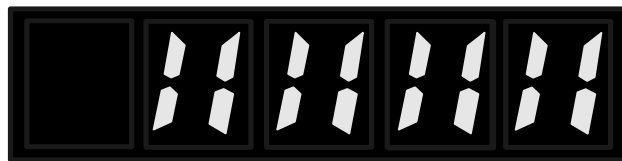

8 7 6 5 4 3 2 1

Upper: corresponding signal status  
Lower: level of corresponding signal

DI number

- Corresponding signal status
  - LED off: signal is inactive
  - LED on: signal is active
- Level of corresponding signal
  - LED off: high level (non-conductive)
  - LED on: low level (conductive)

DI number	Pin (CN2)	Default signal
1	9	S-ON
2	10	C-MOD
3	34	POT
4	8	NOT
5	33	CLR
6	32	A-RESTART
7	31	INHIBIT
8	30	ZEROSPD

- Even without external signal inputs, by modifying PA 508 & PA509, user can still make corresponding signal active.

### 5.2.3 Examples of dP 12 LED displays

- PA508.0=0: S-ON is active, DI 1 is low level and low level is active.



- PA508.0=1: S-ON is inactive; DI 1 is low level and high level is active.

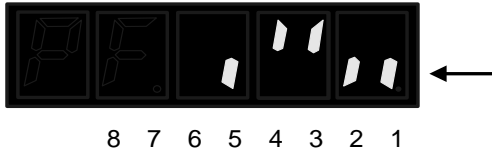



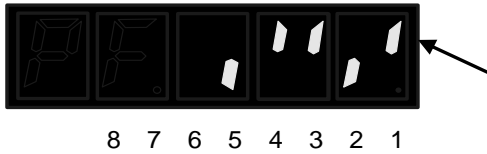



- PA508.0=1, S-ON is active; DI 1 is high level and high level is active.

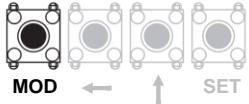

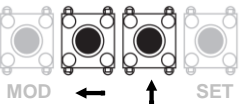
## 5.3 Output signal monitoring (dP 13)

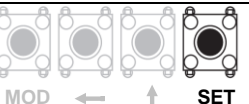
### 5.3.1 Operations of entering dP 13

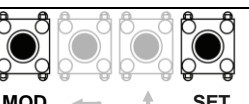
Steps	Panel display	Keys	Operations
1			Press MOD key to choose monitoring display function.
2			If the panel display is not dP 13, press ↑ & ← until it is dP 13.
3			Press SET to enter dP 13.
4			Press SET or MOD to exit to Step 1.
5	End of operations		

### 5.3.2 Explanations of dP 13 LED displays

Output signal status are shown by the LED displays.



Upper: corresponding signal status  
 Lower: level of corresponding signal  
 DO number

- Corresponding signal status
  - LED off: signal is inactive
  - LED on: signal is active
- Level of corresponding signal
  - LED off: high level (non-conductive)
  - LED on: low level (conductive)

DO number	Pin (CN2)	Default signal
1	7, 6	ALM
2	5, 4	COIN
3	3, 2	CZ
4	1, 26	BK

- Even output signal is inactive, by modifying PA 511, user can still make corresponding signal active.
- dP13 is always off if the output signal is CZ.

### 5.3.3 Examples of dP 13 LED displays

- PA511.0=0: ALM is inactive; DO 1 is low level.



- PA511.0=0: ALM is active; DO 1 is high level.



- PA511.0=1: ALM is active; DO 1 is low level.

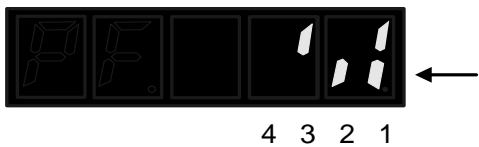

### 5.4 Initial monitoring display at power on

- If PA014 is not 50, then user can set which monitoring display parameter to display at power on.
- If PA014=50 (default), then status codes will be displayed at power on (refer to chapter 4.3)

### 5.5 Display range of dP 01~dP 06

- Display range of dP 01, dP 03 and dP 05 is  $[-32767, 32767]$ .  
A left-most decimal point is used for displaying -32767.

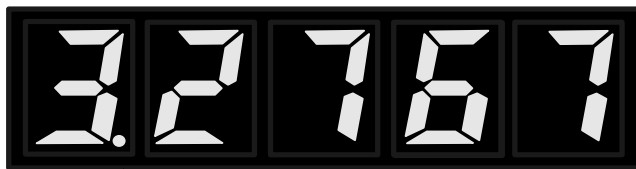

↑  
Number is negative.

- When the absolute value of motor feedback pulse number ( $dP\ 02 \times 10^4 + dP\ 01$ ), input pulse number before electronic gear ( $dP\ 04 \times 10^4 + dP\ 03$ ) and deviation pulse number ( $dP\ 06 \times 10^4 + dP\ 05$ ) exceeds 327679999, the monitoring display will not be updated.

# Chapter 6 Auxiliary functions







## 6.1 List of auxiliary function parameters

No.	Function	Reference
AF 00	Display of alarm logging	6.2
AF 01	Position assignment (only active in position control mode)	6.3
AF 02	JOG run	6.4
AF 03	Panel lock	6.5
AF 04	Clearance of alarm logging	6.6
AF 05	Parameter initialization	6.7
AF 06	Analog instruction (speed & torque) automatic offset adjustment	6.8
AF 07	Speed instruction manual offset adjustment	6.9
AF 08	Torque instruction manual offset adjustment	6.10
AF 09	Overview of relevant motor parameters	6.11
AF 10	Display of main software version of servo drive	6.12
AF 11	Setting up absolute encoders	6.13
AF 12	Clearance of error logging for absolute encoders	6.13
AF 15	Manual detection of load inertia	6.14

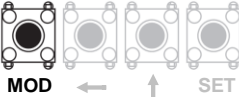

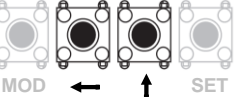
## 6.2 Display of error logging (AF 00)

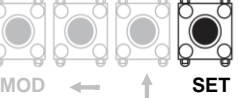
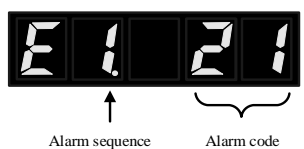
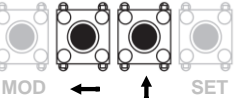
Up to 10 most recent alarms can be displayed.

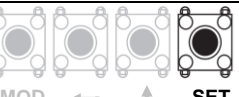
Steps	Panel display	Keys	Operations
1			Press MOD key to choose auxiliary function mode.
2			If the panel display is not AF 00, press ↑ & ← until it is AF 00.
3			Press SET to enter AF 00.
4			Press “←” once and it will display one previous alarm. Press “↑” once and it will display a new alarm. The bigger the number on the left side, the older the alarm displayed.
5			Press SET to exit to Step 2.
6	End of operations.		

Notes:

- When there have been no alarms, the alarm No. is 0.
- The alarm logging can be deleted through Clearance of Alarm Logging (AF 04).
- A-RESTART or power off cannot clear the alarm loggings.

## 6.3 Position assignment (AF 01)

With this function, motor feedback position & instruction pulse position is assigned by value of PA766 & PA767.

This parameter will also reset the values in dP 01 ~ dP06.

Steps	Panel display	Keys	Operations
1			Press MOD key to choose auxiliary function mode.
2			If the panel display is not AF 01, press ↑ & ← until it is AF 01.
3			Press SET to enter AF 01.
4			Press and hold ↑.
5			
6			Release the key.
7			Press MOD or SET to exit to Step 2.
8	End of operations.		

## 6.4 JOG run (AF 02)

JOG run is the function to confirm the servo motor action through speed control without connecting to the upper controller. During JOG run, the overtravel prevention function (POT, NOT) is inactive. **User shall pay close attention to mechanical movement of the machinery caused by JOG run.**

### 1) Preparing for JOG run

Before JOG run, the following settings are necessary.

- When S-ON input signal is ON, please switch it to OFF.
- Please set the JOG speed after considering mechanical movement of the machinery. **JOG speed can be set by PA306.**
- Please take necessary safety measures and ensure it can stop at any emergency.
- In order to ensure safety, a stop device shall be set on the machine side.

### 2) JOG run procedures

Steps	Panel display	Keys	Operations
1			Press MOD key to choose auxiliary function mode.
2			If the panel display is not AF 02, press ↑ & ← until it is AF 02.
3			Press SET to enter AF 02.
4			<i>This will show if the servo is running or panel is locked (AF 03).</i>
5			Press MOD to enable the servo.
6			Press ← to JOG forward or ↑ to JOG reversely.
7			Press MOD (or SET) to stop enabling the servo.
8			Press SET to exit to Step 2.
9	End of operations.		









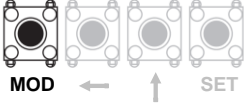

## 6.5 Panel lock (AF 03)

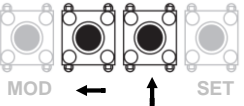
Password settings:

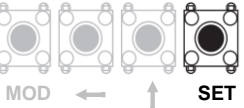
- When it is set to be 58, no parameters or functions can be operated.
- When it is set to be 315, all parameters and functions (even hidden) can be operated.
- When it is set to be any other value, only the parameters and functions listed in the user manual can be operated.

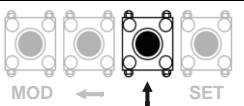



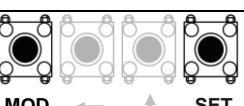



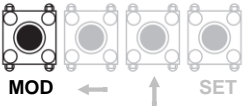

Steps	Panel display	Keys	Operations
1			Press MOD key to choose auxiliary function mode.
2			If the panel display is not AF 03, press ↑ & ← until it is AF 03.
3			Press SET.
4			Press SET to enter AF 03
5			Press ↑ or ← to set the password.
6			Press SET to finish password setting and exit to Step 2.
7	End of operations.		

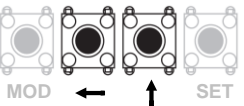
## 6.6 Clearance of alarm logging (AF 04)

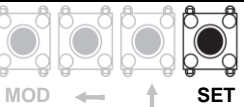
Steps	Panel display	Keys	Operations
1			Press MOD key to choose auxiliary function mode.
2			If the panel display is not AF 04, press ↑ & ← until it is AF 04.
3			Press SET.
4			Press and hold ↑.
5			This shows the operation is done.
6			Release the key.
7			Press MOD or SET to exit to Step 2.
8	End of operations.		

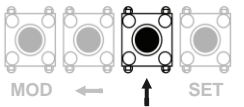
## 6.7 Parameter initialization (AF 05)

To achieve parameter initialization, servo must not be ON. Also, restart afterwards to make initialization effective.

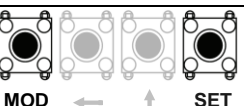
Steps	Panel display	Keys	Operations
1			Press MOD key to choose auxiliary function mode.
2			If the panel display is not AF 05, press ↑ & ← until it is AF 05.
3			Press SET if the servo is not ON.
4			<i>This will show if the servo is running or panel is locked (AF 03).</i>
5			Press and hold ↑.
6			This shows the operation is done.
7			Release the key.
8			Press MOD or SET to exit to Step 2.
9	Power off, then power on again.		
10	End of operations.		

## 6.8 Analog instruction automatic offset adjustment (AF 06)

This is a method for self-regulation of the instruction voltage (speed instruction and torque instruction) after measuring the offset. The measured offset will be saved in the servo drive.

Steps	Panel display	Keys	Operations
1			Press MOD key to choose auxiliary function mode.
2			If the panel display is not AF 06, press ↑ & ← until it is AF 06.
3			Press SET.
4			Press and hold ↑.
5			This shows the operation is done.
6			Release the key.
7			Press MOD or SET to exit to Step 2.
8			End of operations.

## 6.9 Speed instruction manual offset adjustment (AF 07)

This is the method to input the speed instruction offset directly for regulation.

Steps	Panel display	Keys	Operations
1			Press MOD key to choose auxiliary function mode.
2			If the panel display is not AF 07, press ↑ & ← until it is AF 07.
3			Press SET.
4			This will show if the servo is ON.
5			Press SET to display current offset value.
6			Press ↑ or ← for adjustment.
7			Press SET, 'SAVED' will show and blink, then will exit to Step 2.
8			Press MOD to exit to Step 2 without saving.
9	End of operations.		











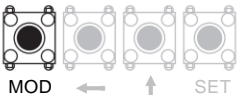

## 6.10 Torque instruction manual offset adjustment (AF 08)

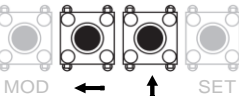
This is the method to input the torque instruction offset directly for regulation.

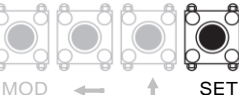

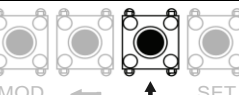

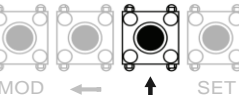

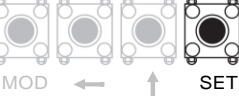

Steps	Panel display	Keys	Operations
1			Press MOD key to choose auxiliary function mode.
2			If the panel display is not AF 08, press ↑ & ← until it is AF 08.
3			Press SET.
4			This will show if the servo is ON.
5			Press SET to display current offset value.
6			Press ↑ or ← for adjustment.
7			Press SET, 'SAVED' will show and blink, then will exit to Step 2.
8			Press MOD to exit to Step 2 without saving.
9	End of operations.		

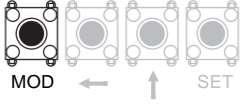
## 6.11 Overview of relevant motor parameters (AF 09)

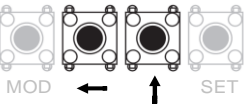
Display the model, encoder type and motor phase of the servo motor connected to the servo drive. If the servo drive has special specifications, its serial number will also be displayed.

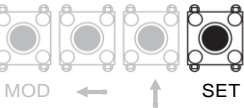
Steps	Panel display	Keys	Operations
1			Press MOD key to choose auxiliary function mode.
2			If the panel display is not AF 09, press ↑ & ← until it is AF 09.
3			Press SET to show the left figure. It means the drive model is 0, and the first letter is identified as "d".
4			Press "↑" to show the motor model, and the first letter is identified as "F".
5			Press "↑" to show the model of encoder. <ul style="list-style-type: none"> <li>▪ 0: multi-turn absolute encoder;</li> <li>▪ 1: single-turn absolute encoder;</li> <li>▪ 2: line-saving incremental encoder.</li> </ul> The first letter is identified as "E".
6			Press SET to exit to Step 2.
7	End of operations.		

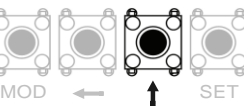
## 6.12 Display of main software version of servo drive (AF 10)

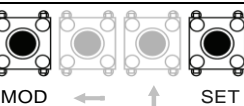
Steps	Panel display	Keys	Operations
1			Press MOD key to choose auxiliary function mode.
2			If the panel display is not AF 10, press ↑ & ← until it is AF 10.
3			Press SET. 'd 1.00': DSP software version is 1.00.
4			Press ↑. F 1.03: FPGA software version is 1.03.
5			Press MOD or SET to exit to Step 2.
6	End of operations.		

## 6.13 Setting up absolute encoders (AF 11)

This function is used under the following conditions:

- Absolute encoder is used for the first time;
- There are alarms related to absolute encoders;
- User intends to set quantity of turns of a multi-turn encoder to 0.

Notes:

- Servo must be OFF;
- A-RST cannot clear alarms related to absolute encoders;
- Power off and power on again after setting;
- This operation will set quantity of turns of a multi-turn encoder to 0 and clear all alarms related to absolute encoders







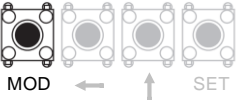

Steps	Panel display	Keys	Operations
1			Press MOD key to choose auxiliary function mode.
2			If the panel display is not AF 11, press ↑ & ← until it is AF 11.
3			Press SET.
4			Press and hold ↑.
5			This shows the operation is done.
6			Press MOD or SET to exit to Step 2.
7	Power off and power on again.		
8	End of operations.		

## 6.14 Manual detection of load inertia (AF 15)

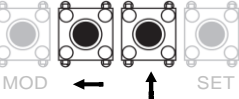
Overtravel prevention is inactive during the process of manual detection of load inertia.

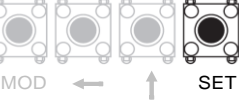
### Preparations before operation

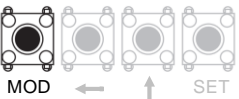
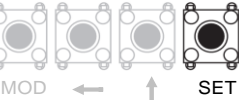
- Servo is OFF;
- Please set PA300.2 for running distance of the motor in this operation, after careful study of all related mechanical parts.
- Please take necessary safety measures, e.g. a stop device on the machine side, for emergency stops.

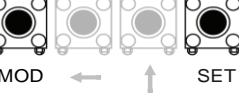
Steps	Panel display	Keys	Operations
1			Press MOD key to choose auxiliary function mode.
2			If the panel display is not AF 15, press ↑ & ← until it is AF 15.
3			Press SET.
4			<i>This will show if the servo is running or panel is locked (AF 03).</i>
5			Press MOD to run manual detection of load inertia.
6			During operation, press SET for emergency stop.
7			Load inertia will display after operation, unit: Kg*cm <sup>2</sup>
8			Press MOD or SET to exit to Step 2.
9	End of operations.		

# Chapter 7 JOG run

## 7.1 Preparations before JOG run

Please check the following items before JOG run:

Item	What to check
Servo motor	Whether the motor has been released from load?
	Whether the wiring and connection are correct?
	Whether the fastening parts are loose?
	If the servo motor has a holding brake, whether the brake has been released (by separate 24VDC) in advance?
Servo driver	Whether the wirings and connections are correct?
	Whether the input voltage to the servo drive is stable?

## 7.2 JOG run by panel operations

Please refer to Chapter 6.4

## 7.3 Stand-alone JOG run with upper controllers

Please check the following items before JOG run by instructions from upper controllers:

Item	What to check
1	Whether I/O signals are correctly set?
2	Whether the connections between upper controller and servo drive is correct and whether the polarities are set correctly?
3	Whether the instructions are correctly set?

### 7.3.1 Wiring & status check of input signal circuit

Steps	Operations	Reference
1	Please make sure following signals are connected to CN2: <ul style="list-style-type: none"><li>▪ S-ON</li><li>▪ POT &amp; NOT</li></ul>	3.3
2	Connect servo drive to upper controller.	-
3	Power on. Check status of dP 12.	4.3
4	Input S-ON to enable the servo.	4.3
5	End of preparations for JOG run.	-

### 7.3.2 JOG run in position control mode

Steps	Operations	Reference
1	Reconfirm the power supply and input signal circuit and then switch on the control power supply of servo drive.	3.1
2	Use PA200.0 to set the input pulse form.	8.4.1
3	Use PA205 and PA206 to set the electronic gear ratio; Use PA210 to set encoder divided frequency pulse number.	8.4.2 8.5.7
4	Power on again.	-
5	Input S-ON to enable the servo.	-
6	Output low speed pulse instruction from the upper controller with easily confirmed motor rotation (such as: 1 turn).	-
7	Monitor the input pulse number (dP 03 & dP 04).	5.1
8	Monitor feedback pulse number (dP 01 and dP 02).	5.1
9	Confirm whether the servo motor rotates in the direction given by the instruction.	-
10	Check whether the number of feedback pulse corresponds with the expected number. <b>Feedback pulse number = (dP 01*10<sup>4</sup>+dP 02) *PA210*4/ encoder resolution</b>	5.1
11	Stop the pulse instruction and make the servo OFF.	-

### 7.3.3 JOG run in speed control mode

Steps	Operations	Reference
1	Reconfirm the power supply and input signal circuit and then switch on the control power supply of servo drive.	3.1
2	Adjust speed instruction input gain by PA301.	8.5
3	Power on.	-
4	Confirm the speed instruction input (voltage between V- REF and AGND) is 0 V, and then switch on the servo ON (S-ON) input signal.	-
5	Increase speed instruction input voltage (voltage between V-REF and AGND) from 0V slowly.	-
6	Confirm the speed instruction value (voltage) through the speed instruction monitoring (dP 07).	5.1
7	Confirm the motor speed (rotating speed) through motor speed monitoring (dP 00).	5.1
8	Confirm the values in procedures 6 and 7 (dP07 and dP00) are consistent according to the conversion relation.	5.1
9	Confirm whether the servo motor rotates in the direction given by the instruction.	-
10	Return speed instruction input to 0V, and make the servo OFF. Then the speed test run is finished.	-



## 7.4 JOG run with mechanical connections

After stand-alone JOG run, user can then proceed to JOG run with mechanical connections.

Steps	Items	Operations	Reference chapter
1	Parameter setting 1	Power on and conduct the setting related to the safety functions, overtravel and brake protection functions.	3.1 8.2
2	Parameter setting 2	Set the necessary parameters according to the control mode used.	-
3	Installation	Power OFF and connect the servo motor with the mechanical parts.	-
4	Check	Power on upper controller but keep the servo OFF, and then confirm whether the protection functions set in Step 1 function normally.	-
5	Operation	Conduct JOG run same way as Chapter 7.3. Confirm the JOG run result is up to expectations with mechanical connections.	7.3
6	Adjustment	Adjust the servo gains (if necessary) to improve the response characteristic of servo motor. During the JOG run, the servo motor may not adapt to the machine well at the beginning. Please conduct fine tune to make them adapt to each other.	-
7	Finish	Then, the JOG run is finished.	-

## 7.5 JOG run with a holding brake

Item	Remarks
1	When conducting JOG run of the servo motor with a brake, before confirming the action of brake, measures to prevent the natural fall or vibration due to external force of the machine shall be taken.
2	When conducting the JOG run of servo motor with a brake, please first of all confirm the action of servo motor and holding brake before connecting the servo motor with the machine. If there are no problems, conduct the JOG run again by connecting the servo motor with the machine.
3	Please control the action of the holding brake BK signal.

# Chapter 8 Servo operations

## 8.1 Control mode selections

Parameter	Control mode	Reference
PA000.1	<b>Position control (pulse train instruction)</b> The position of servo motor is controlled through the pulse train position instruction. The position is controlled through the pulse number inputted, and speed is controlled through the frequency of input pulse. It is used when the action needs to be positioned.	8.4
	<b>Speed control (analog voltage instruction)</b> Use this under the following occasions: <ul style="list-style-type: none"> <li>▪ To control the rotating speed;</li> <li>▪ Use the encoder pulse output of servo drive and establish the position loop through the upper controller for position control.</li> </ul>	8.5
	<b>Torque control (analog voltage instruction)</b> Use the analog voltage torque instruction to control the output torque of servo motor.	8.6
	<b>Internal speed control</b> Use 3 input signals, INSPD0, INSPD1 and INSPD2, for speed control through the 8 preset speeds in the servo drive. When this control mode is used, the analog instruction is not needed.	8.7
	<b>Internal speed control ↔ Position control</b>	8.10
	<b>Internal speed control ↔ Speed control</b>	8.10
	<b>Internal speed control ↔ Torque control</b>	8.10
	<b>Position control ↔ Speed control</b>	8.10
	<b>Position control ↔ Torque control</b>	8.10
	<b>Torque control ↔ Speed control</b>	8.10
	<b>Internal position control</b> System positions will be controlled without the upper controller.	8.8
	<b>Internal position control ↔ Position control</b>	8.10
	<b>Reserved</b>	
<b>Fully closed loop control</b>	8.11	

## 8.2 Basic function settings

### 8.2.1 S-ON settings

- S-ON is the instruction for servo motor on/off

Type	Signal	Status	Level	Remarks
Input	S-ON	ON	2CN-9: Low	Servo is ON & ready for operations.
		OFF	2CN-9: High	Servo is OFF.

- Selection of S-ON level

Parameter		Remarks
PA508	b.□□□0	L level active (optocoupler conductive) (default)
	b.□□□1	H level active (optocoupler not conductive)

## 8.2.2 Switch of motor rotational directions

The servo drive can enable the servo motor to rotate reversely (negative rotation mode) without changing the wiring of servo motor.

The positive direction is counter clockwise rotation (CCW). Negative mode only changes the rotational direction of the motor and positive direction becomes clockwise rotation (CW), and **encoder pulse output polarity remains unchanged**.

Parameter	Instructions & rotational directions	Overtravel (OT)
PA000	<p>■ Rotational direction at positive instruction</p> <p>Speed</p> <p>Time</p> <p>Encoder pulse output</p> <p>PAO</p> <p>PBO</p> <p>CCW</p>	POT
	<p>■ Rotational direction at negative instruction</p> <p>Speed</p> <p>Time</p> <p>Encoder pulse output</p> <p>PAO</p> <p>PBO</p> <p>CW</p>	NOT
	<p>■ Rotational direction at positive instruction</p> <p>Speed</p> <p>Time</p> <p>Encoder pulse output</p> <p>PAO</p> <p>PBO</p> <p>CW</p>	NOT
	<p>■ Rotational direction at negative instruction</p> <p>Speed</p> <p>Time</p> <p>Encoder pulse output</p> <p>PAO</p> <p>PBO</p> <p>CCW</p>	POT

## 8.2.3 Overtravel (OT) settings

Overtravel refers to the safety function which can make the limit switch function (ON) and force the servo motor to stop when the moving parts of a machine go beyond the movable area.

<b>Attention</b>	
<b>Installation of limit switches</b>	
Limit switches must be installed in applications such as linear motions. When the limit switch has bad contacts or broken wires, please use ‘normally closed nodes’ to ensure the motor moves to the safer side.	
<b>Use of servo motors in vertical axis</b>	
Work piece might fall when overtravel. To prevent this, please set the servo into zero-speed clamp when overtravel.	

### (1) Wiring for overtravel

Type	Signal	Pin	Setting	Meaning
Input	POT	CN2-34 (default)	ON=L level	Can forward run
			OFF=H level	Forward run prohibited (positive overtravel)
Input	NOT	CN2-8 (default)	ON=L level	Can reverse run
			OFF=H level	Reverse run prohibited (negative overtravel)

When in overtravel, servo can still move in the opposite direction.

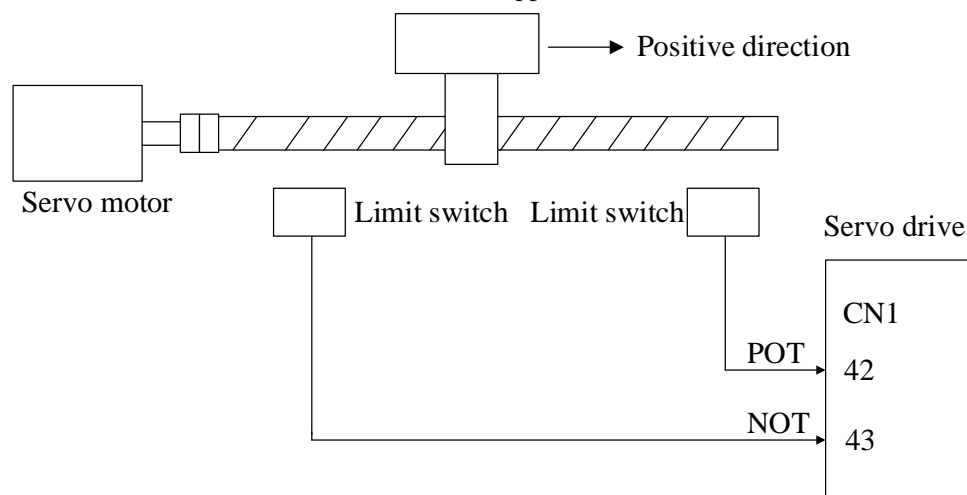

### Important

- There might be position deviation pulse residual at overtravel in position control. To clear the residual, use CLR signal.
- POT, NOT can be allocated to other Pins.
- To use POT, NOT, please set PA003.0 & PA003.1 to 0.

## (2) Selection of servo stop patterns at overtravel

Parameter		During stop	After stop	Meaning
PA001	d.□□0□ d.□□□0	DB to stop	DB state	DB to stop and maintain DB state after stop.
	d.□□0□ d.□□□1		Free state	DB to stop and enter free state (power off) after stop.
	d.□□0□ d.□□□2	Coast to stop		Coast to stop and enter free state (power off) after stop.
	d.□□1□	Decelerate to stop	Zero-speed clamp state	Use emergency stop torque (PA406) to decelerate and enter zero-speed clamp state after stop.
	d.□□2□		Free state	Use emergency stop torque (PA406) to decelerate and enter free state (power off) after stop.

- Please restart the servo drive after modifying this parameter.
- If the servo receives S-ON signal during coast to stop, the servo motor can only be controlled after the speed has decelerated to 0.
- Definitions:
  - DB: dynamic brake (internal short-circuit of servo drive). This feature is optional.
  - Coast to stop: stop using natural frictions.
  - Zero-speed clamp: the state when position instruction is 0 and position deviation is cleared.

## (3) Enable overtravel signal

Parameter	Description	
PA003	b.□□□ 0	Forward rotation prohibited (POT) valid
	b.□□□ 1	Forward rotation prohibited (POT) invalid (default)
	b. □□ 0 □	Reverse rotation prohibited (NOT) valid
	b.□□ 1 □	Reverse rotation prohibited (NOT) invalid (default)

## (4) Stop torque setting during overtravel

PA406	Emergency Stop Torque			
	Range	Unit	Default	Effective
	0 ~ 300	1%	300	Immediately

- Set the torque for motor stop when the overtravel signals (POT, NOT) are valid.
- The setting unit is the % of the rated torque. (the rated torque is 100%)
- When the emergency stop torque exceeds the maximum running torque of the motor, the actual emergency stop torque output is the motor's maximum running torque; When the emergency stop torque is too small, there may be E.28 alarm during deceleration.

## 8.2.4 Holding brake settings

The holding brake is often used when the motor is used in the vertical axis. When the power of servo drive is OFF, the servo motor with a brake can keep the moving parts from moving due to gravity. (Please refer to Chapter 7.5 JOG run with a holding brake)

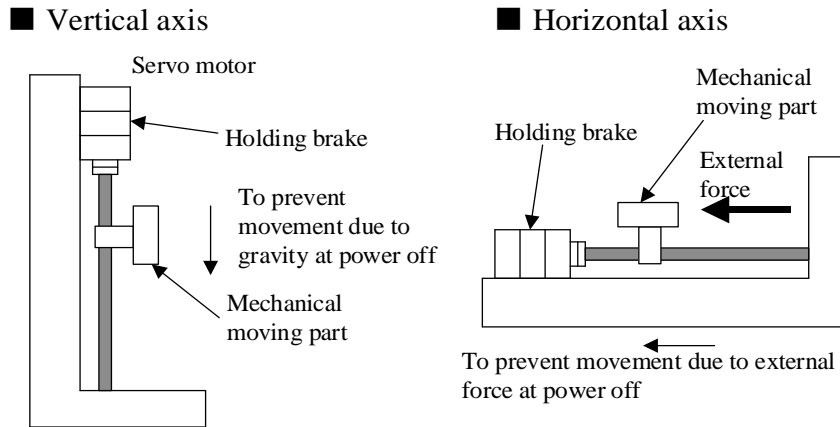

- The holding brake can only be used to maintain the halt state, not braking, of the servo motor. The brake torque is 70% or above of the rated torque of servo motor.
- If only the speed loop is used to activate the servo motor, when the brake functions, set the servo OFF and input instruction to be "0V".
- When setting the position loop, because the servo motor is under servo locked state at stop, the mechanical brake shall not function.

### (1) Example of connection

The sequential output signal of servo drive (BK) and brake power supply forms the ON/OFF of the brake. Standard connection of a circuit is illustrated as follows.

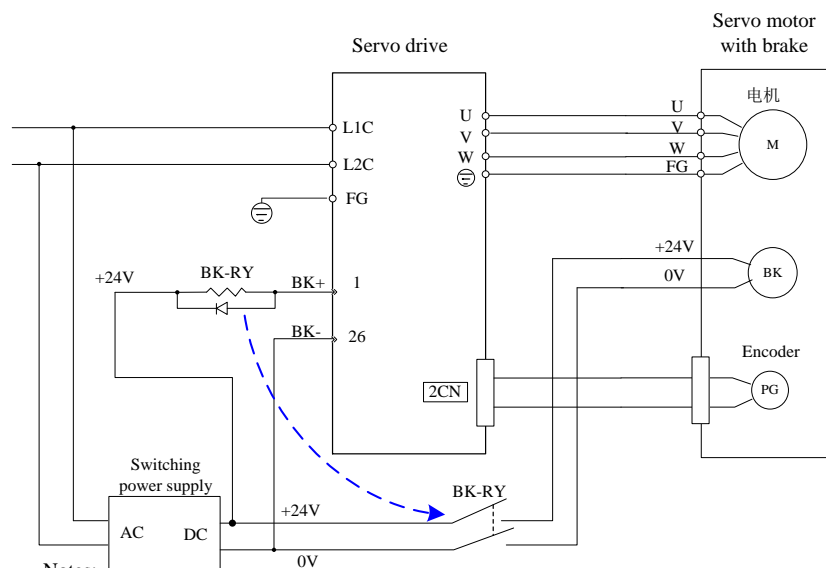

Notes:

1. BK-RY: the relay for brake control
2. The current provided by switching power supply shall be determined by the brake; different brakes have different working currents. Normally, the DC24V of switching power supply shall be provide the current >1A;
3. DC24V input of the brake is not restricted by direction

The brake has delay action time; please refer to the figure below for the order of ON and OFF of the action.

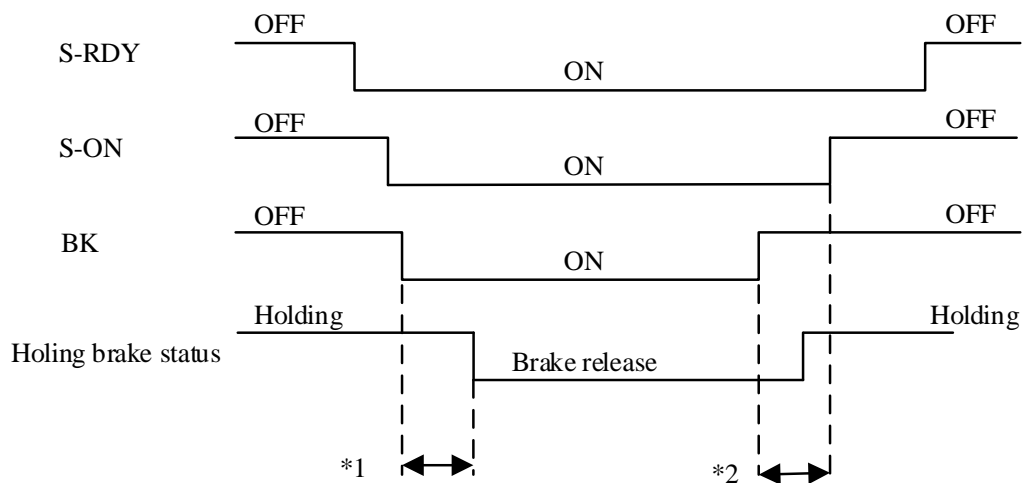

- \*1. The time from BK signal active to brake release is different for different types of brakes
- \*2. PA518 value

## (2) BK signal output

Type	Signal name	Pin	Setting	Meaning
Output	BK	Need allocation	ON=L level	Brake release
			ON=H level	Brake holding

Use of the servo motor with a brake needs to control the output signal of brake. In addition, the output signal is not available in factory default setting. Therefore, it is necessary to allocate the output signal (setting of PA510). Do not connect with it when the motor without a brake is used.

### ■ Important

When overtravel, even the servo motor is powered off, no BK signal can output.

## (3) Allocation of BK signal

Brake signal (BK) is allocated to DO4 (CN2-25, CN2-26) by default, but can also be allocated freely.

Parameter		Pin		Meaning
		+	-	
PA510	h.□□3□	CN2-4	CN2-5	BK signal output from CN2-4, CN2-5
	h.□3□□	CN2-3	CN2-2	BK signal output from CN2-3, CN2-2
	h.3□□□	CN2-1	CN2-26	BK signal output from CN2-1, CN2-26

Please refer to Chapter 3.4.3 'Allocation of I/O signals'



#### (4) BK signal hysteresis time after Servo-OFF

BK signal is normally OFF when servo OFF, but users can change the BK signal hysteresis time after Servo-OFF.

PA518	BK signal hysteresis time after Servo-OFF			
	Range	Unit	Default	Effective
	0~500	ms	100	Immed

When used on a vertical axis, moving parts of the machine sometimes may move slightly due to deadweight or external force. The slight movement may be eliminated by using the user parameter to delay the actions after the servo OFF.

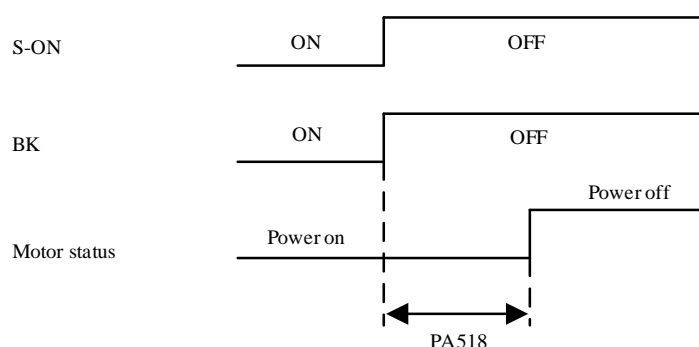

When an alarm is given out, the servo motor will be immediately powered off, and the setting of this parameter becomes irrelevant.

Owing to the deadweight of machine moving parts or the external force, the machine sometimes may move before the brake functions

#### (5) Setting of BK signal timing during the rotation of servo motor

When a halt instruction is given to the rotating servo motor during servo OFF or an alarm, the output conditions of BK signal can be changed according to the following user parameters.

PA519	BK signal speed limit			
	Range	Unit	Default	Effective
	0~1000	rpm	100	Immed

  

PA520	BK signal waiting time at Servo-OFF			
	Range	Unit	Default	Effective
	100~1000	1ms	500	Immed

---

**BK signal will be OFF (H level, nonconductive) in following situations:**

- The motor speed is below PA519 after servo OFF
- The waiting time exceeds PA520 after servo OFF

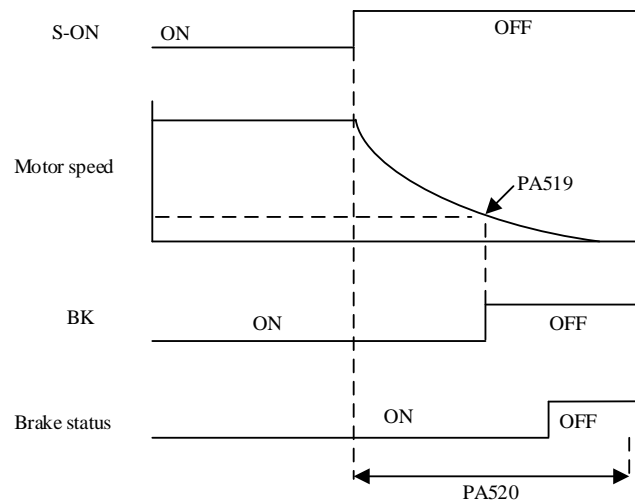

---

Even PA519 is set to be above the maximum speed of the servo motor, the servo motor will be restricted by its own maximum speed.

---

## 8.2.5 Selection of servo stop patterns at servo OFF

Parameter		During stop	After stop	Meaning
PA001	d.□□□0	DB to stop	DB state	DB to stop and maintain DB state after stop.
	d.□□□1		Free state	DB to stop and enter free state (power off) after stop.
	d.□□□2	Coast to stop	Free state	Coast to stop and enter free state (power off) after stop.
	d.□□□3	Decelerate to stop	DB state	Decelerate at rate of PA522, & stay in DB state when speed is lower than PA523.
	d.□□□4		Free state	Decelerate at rate of PA522, & coast to stop when speed is lower than PA523.

- This parameter is valid in following situations:
  - When S-ON signal is OFF;
  - When there is an alarm output;
  - When main power (L1, L2, L3) is off.
- In the above setting "DB state maintenance after DB stops" of "d.□□□0", if the servo motor stops or rotates at a very low speed, no brake force will be generated.
- Definitions:
  - DB: dynamic brake (internal short-circuit of servo drive). This feature is optional.
  - Coast to stop: stop using natural frictions.

---

Dynamic brake (DB) can be used for emergency stop.

When the servo motor is frequently started and stopped through the power ON/OFF or servo ON signal (S-ON), DB circuit will also repeat ON and OFF frequently, which is the main cause for the aging of the interior components of the servo drive. Please start and stop the servo motor through the speed input instruction and position control instruction.

## 8.2.6 Instantaneous power off settings

This is to set when the main power supply is OFF instantly, whether the motor shall go on operating or set to be servo OFF

PA521	Instantaneous power off holding time			
	Range	Unit	Default	Effective
	40~800	1ms	60	Immed

If the OFF→ON resetting time is below the setting value of this parameter, the servo will keep on operating.

But under the following circumstances, the setting of this parameter will not become effective:

- The load of servo motor is too big, which causes "under voltage warning (A.96)" during instantaneous power off;
- When the control power supply is out of control (the same to the usual power OFF operation) during the period of instantaneous power off.

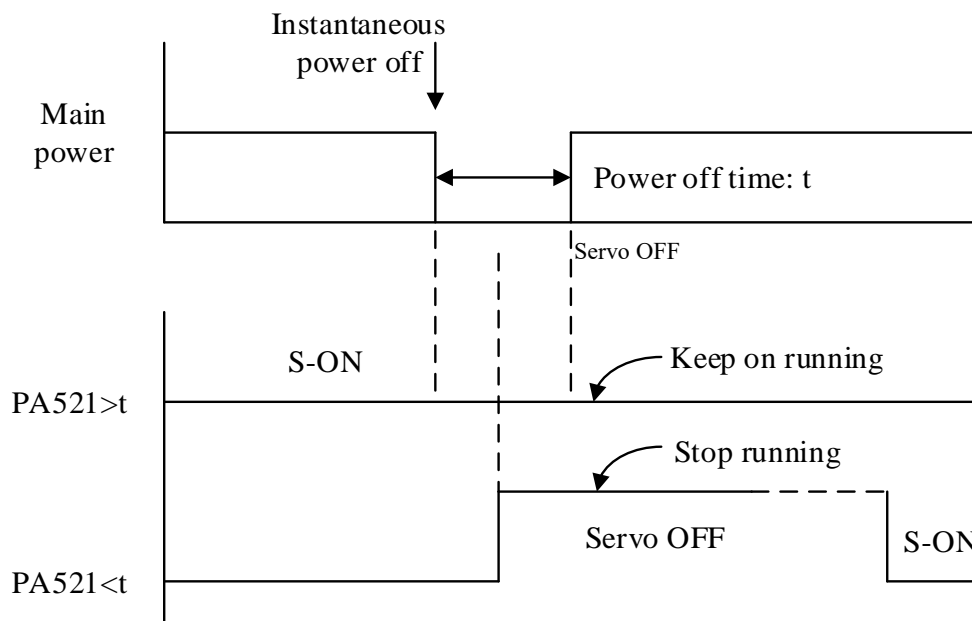

The maximum holding time setting value is 800ms during instantaneous power off, but the holding time of control power supply of the servo motor is about 200ms. The holding time of main power supply varies along with the output of servo drive.

Please use a UPS in order to go on controlling the servo drive if instantaneous power off time is beyond the maximum setting value of this parameter.

## 8.2.7 Analog voltage output

Pin 44 (MON) & Pin 16 (SG) of CN2 provide analog data for monitoring. For example, motor running status. Motor speed and current can also be demonstrated by analog voltage. The range for analog voltage is -8V~+8V.

Parameter		Meaning
PA021	d.□□□	Analog output is motor speed feedback. (default)
	d.□□□1	Analog output is motor torque feedback.
	d.□□0□	Output voltage is not negated. (default)
	d.□□1□	Output voltage is negated.

PA023	Analog voltage output gain			
	Range	Unit	Default	Effective
	0~65535		0	Immed

The corresponding relations are as below:

PA023	Analog output data: speed	When PA023≠0:
0	500rpm = 1V, -1000rpm = -2V	$\text{Output voltage} = \frac{\text{motor speed}}{\text{PA023}}$
500	500rpm = 1V	
1000	1000rpm = 1V	
250	500rpm = 2V	

PA023	Analog output data: torque	When PA023≠0:
0	100% torque = 3V, -100% torque = -3V	$\text{Output voltage} = \frac{\text{torque} \times 1000}{\text{PA023}}$
333	100% torque = 3V, -100% torque = -3V	
222	100% torque = 4.5V, -50%% torque = -2.25V	
666	100% torque = 1.5V, -200%% torque = -3V	

PA024	Analog voltage output zero calibration			
	Range	Unit	Default	Effective
	-8000~8000	mV	0	Immed

## 8.3 Using absolute encoders

If the servo motor with an absolute encoder is used, an absolute value detection system can be set in the instruction control unit. Thus after power on again, the motor can directly run without zero reset.

Encoder type	Resolution	Data output range	Action when exceed the limit
Absolute encoder with multi-turn memory	17-bit	-32768 ~+32767	<ul style="list-style-type: none"> <li>When going beyond the upper limit (+32767) of positive rotation direction, the multi-turn data become -32768.</li> <li>When going beyond the lower limit (-32768) of reverse rotation direction, the multi-turn data become +32767.</li> </ul>

When multi-turn data overflows, E.58 will output. PA007.1 can disable this alarm

Parameter	Meaning
PA007	d.□□0□
	d.□□1□

### 8.3.1 Absolute encoder selection

Parameter	Meaning
PA002	d.□0□□
	d.□1□□

- When use absolute encoders as incremental encoders, no battery is needed.
- After modifying this parameter, restart the servo to take effect.

### 8.3.2 Using battery for absolute encoder

Even the power is OFF, a battery is needed to back up data, so that the absolute encoder can save the position information.

#### (1) Battery selection

Please make preparations according to the specification of instruction control unit; the battery shall be the product equivalent to ER3V (3.6V, 1000mA TOSHIBA battery).

#### (2) Battery installation

The battery shall be mounted inside the battery case of the encoder cable; pay close attention not to reverse the polarities.

### 8.3.3 Battery replacement

When the battery voltage drops to be below 3.1V, the servo drive will output "17-bit serial encoder battery warning (A.97) ". But this warning only output when the servo drive is ON. If the battery voltage is ultralow when the servo drive is powered on, the servo drive will not give any warning. User can modify warning for ultralow battery voltage.

- **Procedures to replace the battery**

1. Please replace the battery when the control power of servo drive is ON.
2. After replacing the battery, please make the servo drive power OFF, so as to clear "17-bit serial encoder battery warning (A.97) ".
3. Restart the power of servo drive; if there is no abnormal action, the battery is successfully replaced.

#### **Important**

When the control power supply of servo drive is OFF and the battery connection has been moved (so has the encoder line), data inside the absolute value encoder will be lost. Therefore, setting of absolute value encoder is necessary. Please refer to Chapter 6.13 Setting up absolute encoders (AF 11).

### 8.3.4 Setting up absolute encoders (AF 11)

Please refer to Chapter 6.13 Setting up absolute encoders (AF 11).

This function is used under the following conditions:

- Absolute encoder is used for the first time;
- There are alarms related to absolute encoders;
- User intends to set quantity of turns of a multi-turn encoder to 0.

Notes:

- Servo must be OFF;
- A-RST cannot clear alarms related to absolute encoders;
- Power off and power on again after setting;
- This operation will set quantity of turns of a multi-turn encoder to 0 and clear all alarms related to absolute encoders

**After AF 11 is done, please restart the servo drive.**

## 8.4 Position control operations

### 8.4.1 Parameter settings

When using pulses for position control, please pay attention to following parameters.

#### 1) Control mode selection

Parameter		Meaning
PA000	h.□□0□	Position control (pulse train)

#### 2) Pulse form selection

Type	Signal	CN2 Pin
Input Low speed channel (<500 Kbps)	PULS+	43
	PULS-	41
	SIGN+	39
	SIGN-	37
High speed channel (<4 Mbps)	HPULS+	38
	HPULS-	36
	HSIGN+	42
	HSING-	40

Parameter	Pulse form	Forward rotation	Reverse rotation
PA200	d.□□00 PULS+ SIGN		
	d.□□01 CW+ CCW		
d.□□02 A phase + B phase			



### 3) Position deviation clearance

Besides CLR signal, a timed position deviation clearance can be selected by parameter PA200.2.

Parameter		Meaning
PA200	d. 0□□□	Clear position deviation when S-ON is off, power is off or by CLR signal.
	d. 1□□□	Clear position deviation only by CLR signal.
	d. 2□□□	Clear position deviation only when servo has alarm or by CLR signal.

### 4) Input pulse channel selection

User can select input pulse channel by PA200.3.

Parameter		Meaning
PA200	d. 0□□□	<b>PULS+SIGN input: low speed pulse channel</b> Pulse input in this channel is received by optocoupler. It is suitable for upper controller of collector output and long-line transmitter output, frequency $\leq 500K$ bps.
	d. 1□□□	<b>HPULS+HSIGN input: high speed pulse channel</b> Pulse input in this channel is received by long-line receiver. It is suitable for upper controller of long-line transmitter output, frequency $\leq 4M$ bps.

## 8.4.2 Electronic gear

### 1) Encoder resolutions

Parameter	Encoder type	Pulses per revolution	Resolution
PA002	d. 0□□□	Absolute encoder	32768
	d. 1□□□	Incremental encoder	32768
	d. 2□□□	Incremental encoder	5000
	d. 7□□□	Resolver	4096
	d. 8□□□	Incremental encoder	262144

Remarks: encoder resolution is 4 times (quadruple frequency) of encoder pulses per revolution.

### 2) Electronic gear ratio

The function of electronic gear is for setting the work-piece moving distance by 1 pulse instruction (1 instruction unit).

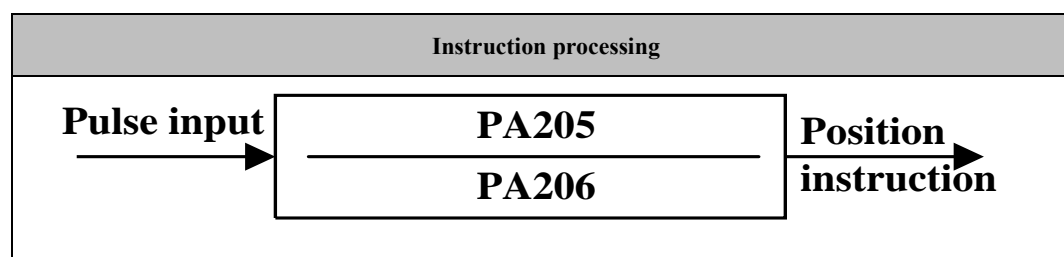

### 8.4.3 Position instructions

Upper controller's output forms include the following:

- Field-bus output
- +24V open-collector output
- +12V open-collector output
- +5V open-collector output

Open-collector output signals can only connect to servo drive's CN2-43, 41, 39, 37, and the parameter should be set to low speed pulse channel, i.e. PA200.3=0 (factory default).

In case of open-collector pulse input, the interference tolerance for input signal will decrease. In case of deviation due to interference, changes should be made in the following user parameters.

#### 1) Example of I/O signal time sequence

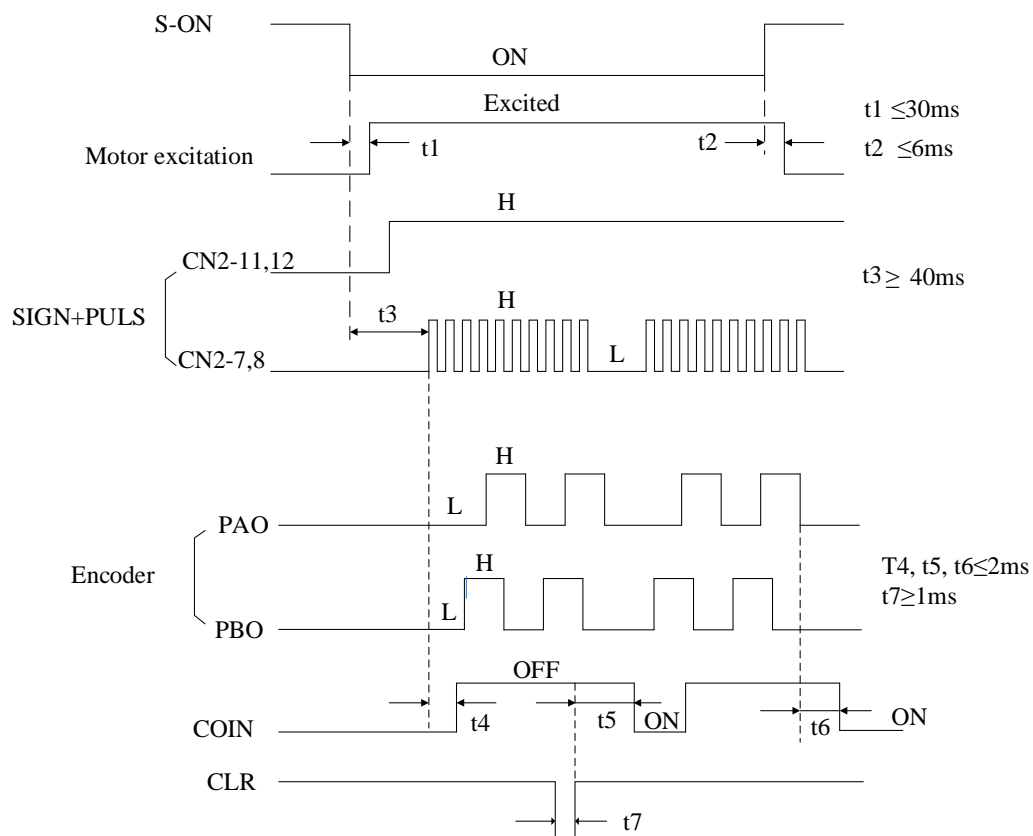

- The interval between S-ON signal and input pulse instructions should be above 40ms. If this interval is less than 40ms, servo drive may fail to receive the pulse instructions.
- Please set CLR signal to be above 20  $\mu\text{s}$ .

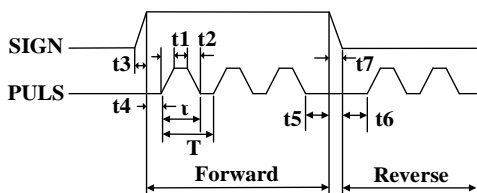
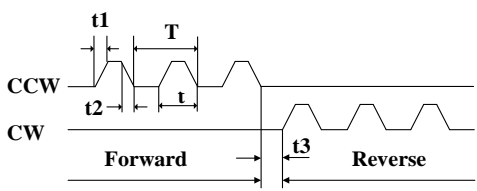
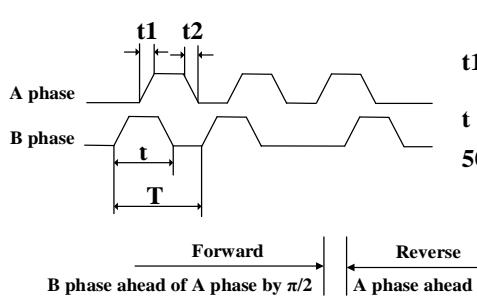
Pulse forms	Maximum frequency	Specifications
SIGN+ PULS	500Kbps. Open-collector: 200Kbps	 <p> <math>t1, t2 \leq 0.1\mu s</math>  <math>t3, t7 \leq 0.1\mu s</math>  <math>t4, t5, t6 &gt; 3\mu s</math>  <math>t \geq 1.0\mu s</math>  <math>50\% &lt; (t/T) \leq 100\%</math> </p>
CW+ CCW	500Kbps. Open-collector: 200Kbps	 <p> <math>t1, t2 \leq 0.1\mu s</math>  <math>t3 &gt; 3\mu s</math>  <math>t \geq 1.0\mu s</math>  <math>50\% &lt; (t/T) \leq 100\%</math> </p>
A phase+ B phase	200Kbps. Open-collector: 150Kbps	 <p> <math>t1, t2 \leq 0.1\mu s</math>  <math>t \geq 1.0\mu s</math>  <math>50\% &lt; (t/T) \leq 100\%</math> </p> <p>           Forward: B phase ahead of A phase by <math>\pi/2</math>            Reverse: A phase ahead of B phase by <math>\pi/2</math> </p>

## 2) Connection examples

Refer to Chapter 3.4.4

## 8.4.4 Smoothness

The servo drive can filter pulse instructions within certain frequency ranges.

PA214	<b>Position instruction acceleration/deceleration time constant 1</b>			
	Range	Unit	Default	Effective
	0~1000	0.1ms	0	Immed
PA215	<b>Position instruction acceleration/deceleration time constant 2</b>			
	Range	Unit	Default	Effective
	0~1000	0.1ms	0	Immed
PA216	<b>Position instruction average-moving filter</b>			
	Range	Unit	Default	Effective
	0~500	0.1ms	0	Immed

If position instruction acceleration/deceleration time constants (PA214, PA215) are changed, the changed value takes effect only if there's no simultaneous pulse input. In order to truly reflect the set value, please input CLR signal to prohibit pulse instructions.

Even in the following cases, motor can operate smoothly. Also this setting has no

effect on movement amount (instruction pulse count).

- The upper controller that sends the instructions can't accelerate or decelerate.
- The frequency of instruction pulse is low
- The electronic gear ratio is relatively high (more than 10 times)

Effects of PA214, PA215, PA216 are shown as below:

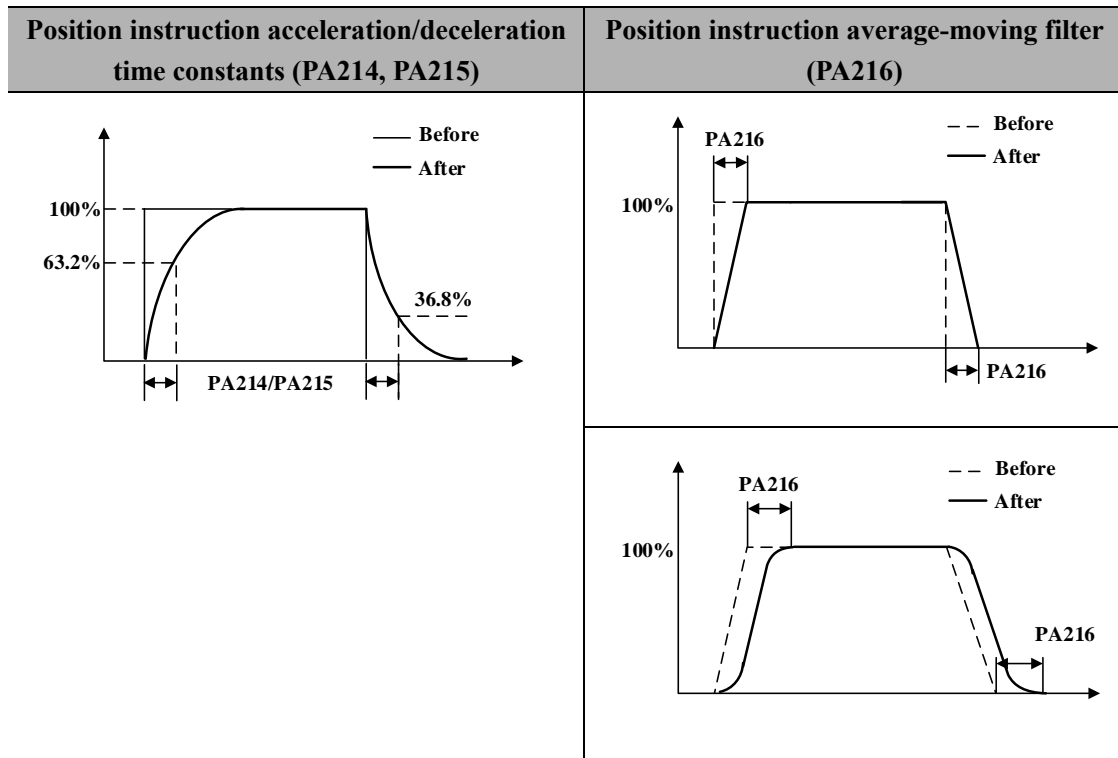

### 8.4.5 Positioning completed signal (COIN)

This signal means that servo motor positioning is completed at position control.

Type	Signal	Pin	Level	Name
Output	COIN	CN2-5, 4 (default)	ON=L level	Positioning completed
			OFF=H level	Positioning not completed

PA525	COIN signal width			
	Range	Unit	Default	Effective
	0~65535	1pulse	10	Immed

- If the difference between the upper controller's instruction pulse input count and the servo motor's movement amount (deviation pulse) is lower than the set value of this use parameter, then the COIN signal will output; this also depends on the electronic gear setting.
- If the set value of PA525 is too high and servo is running in low speed, COIN signal may still output even though positioning is not completed. Please pay close attention to this.

- Setting of this user parameter does not affect the final positioning precision.
- Please refer to 3.4.3 Allocation of I/O signals.

### 8.4.6 Positioning near signal (NEAR)

### 8.4.7 Pulse input inhibited (INHIBIT)

This is a function that stops (inhibits) instruction pulse input counting in case of position control.

It is in servo locking (clamping) state when this function is used.

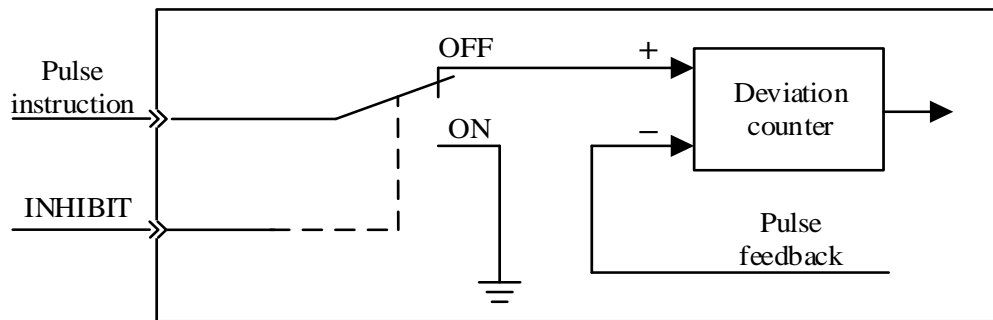

Type	Signal	Pin	Level	Name
Input	INHIBIT	CN2-31 (default)	ON=L level	INHIBIT is ON
			OFF=H level	INHIBIT is OFF

INHIBIT is only valid in position control mode.

## 8.5 Speed control operations

### 8.5.1 Parameter settings

Parameter	Meaning
PA000	h.□□1□

Control mode selection: speed control

When PA000.1 = 1, 5, 7, 9, speed control is being used.

PA301	Speed instruction gain			
	Range	Unit	Default	Effective
	150~3000	0.01V/ rated speed	600	-

This parameter is for setting the instruction voltage (V-REF) at motor rated speed.

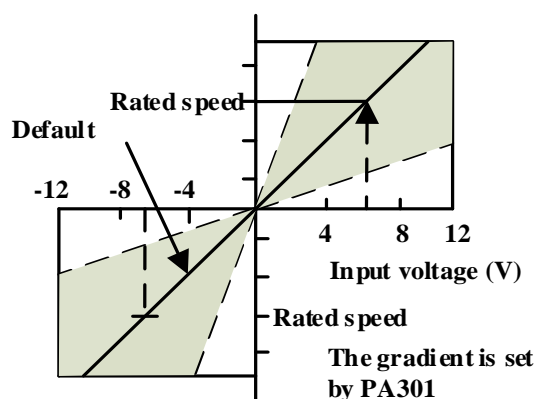

**Input voltage range: DC  $\pm 2V \sim \pm 10V$  / rated speed**

Examples:

- PA301=600 means that with 6V input, the motor will at the rated speed (default) ;
- PA301=1000 means that with 10V input, the motor will at the rated speed.

### 8.5.2 Input signals

#### 1) Speed instruction input

If speed instruction is sent to the servo drive, servo motor will run at a speed proportional to input voltage.

Type	Signal	Pin	Name
Input	V-REF	CN2-20	Speed instruction input
	AGND	CN2-29	GND for speed instruction input

Please use multi-strand twisted wire to prevent interferences.

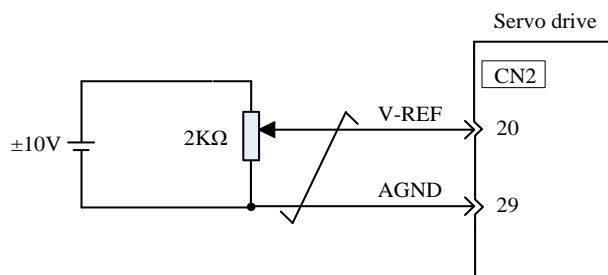

Programmable controller and so on are used for connection with the instruction controller's speed instruction output terminal in case of position control by

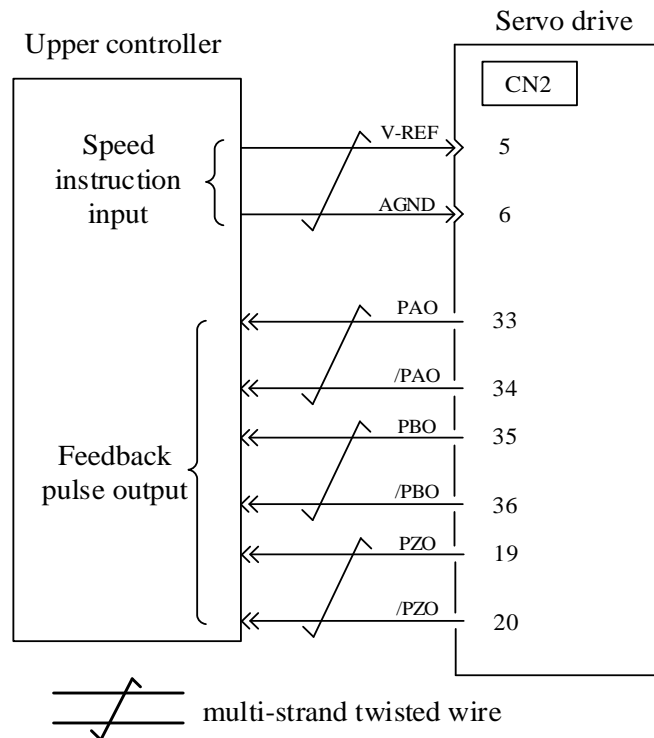

## 2) Proportional action instruction signal (P-CON)

Type	Signal	Pin	Level	Name
Input	P-CON	To be allocated	ON=L level	Operate the servo drive in proportional (P) mode;
			OFF=H level	Operate the servo drive in proportional & integral (PI) mode

- P-CON signal is a signal in respect of which speed control mode is selected from PI (proportional and integral) or P (proportional) control.
- If it's set to P, then control can relieve motor rotation and slight vibration caused by speed instruction input drifting.
- Input instruction: It can progressively reduce servo motor rotation caused by drifting at 0V, but servo rigidity (support strength) decreases at stop.
- **This signal is temporarily unavailable.**

### 8.5.3 Instruction offset adjustment

When in speed control mode, even with 0V instruction, the motor may still rotate at a slight speed. This happens when instruction voltage of upper controller or external circuit has slight (mV unit) deviation (offset). In this case, instruction offset can be adjusted automatically or manually by using the panel operator. Please use automatic or manual offset adjust by referring to Chapter 6.8 & 6.9.

Automatic offset adjustment is the function of offset measuring and automatic voltage adjustment. When the voltage instruction of upper controller and external circuit is deviated, the servo drive will adjust the offset automatically as follows:

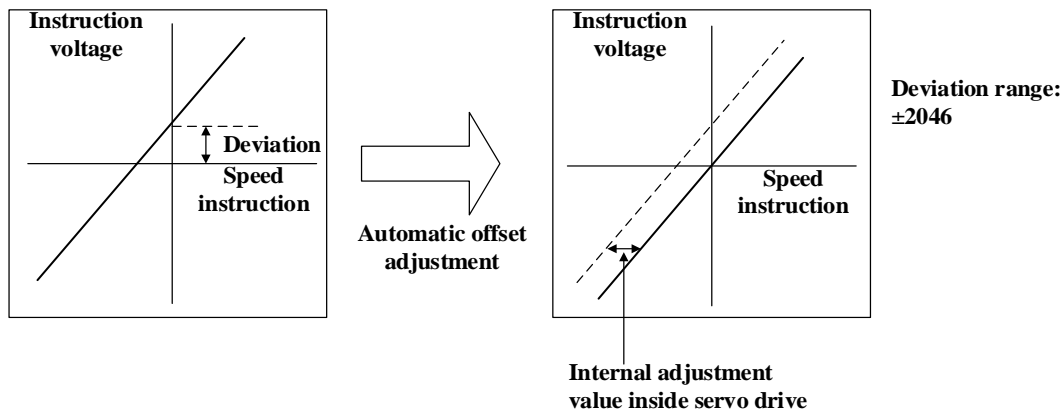

#### 1) Analog instruction automatic offset adjustment (AF 06)

Please refer to Chapter 6.8.

#### 2) Speed instruction manual offset adjustment (AF 07)

Use AF 07 in following situations (Please refer to Chapter 6.9) :

- When servo is locked and deviation pulse is set to 0, AF 06 can't be used.
- When user wants to set offset to a certain value;
- When the offset value is confirmed by AF 06.

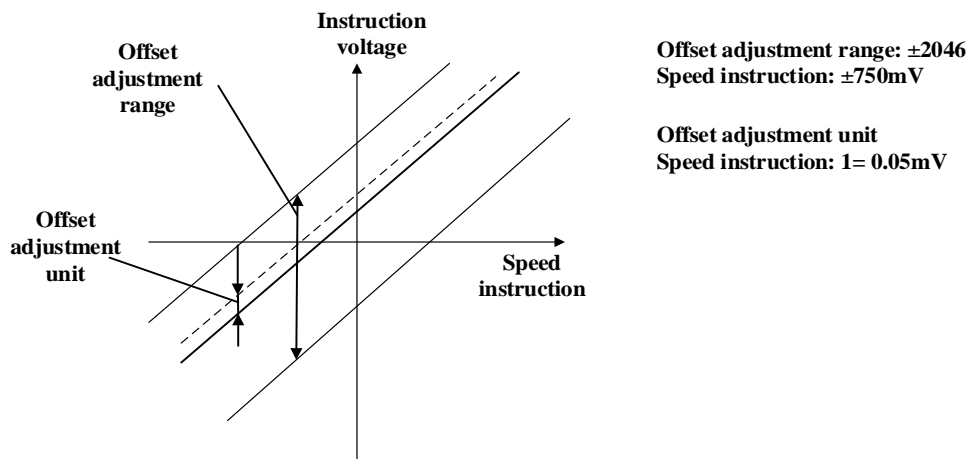



## 8.5.4 Soft start

Soft start is the function that phase step speed instruction input is transformed to instruction with certain acceleration and deceleration curves inside servo drive, thus to achieve smooth operations.

<b>PA303</b>	<b>Soft start acceleration time</b>			
	Range	Unit	Default	Effective
	0~5000	1ms	0	Immed
<b>PA304</b>	<b>Soft start deceleration time</b>			
	Range	Unit	Default	Effective
	0~5000	1ms	0	Immed

- PA303: Acceleration time from 0rpm to 1000rpm;
- PA304: Deceleration time from 1000rpm to 0rpm.

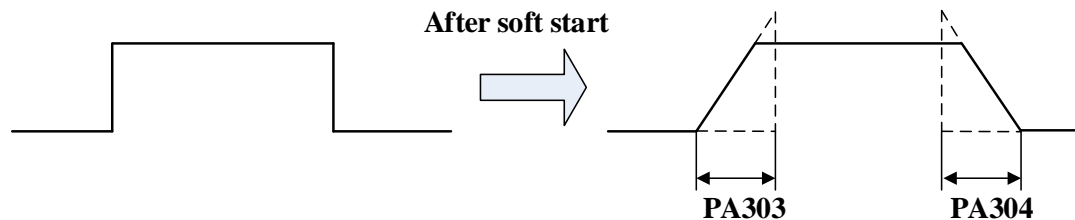

## 8.5.5 Speed instruction filter time constant

<b>PA302</b>	<b>Speed instruction filter time constant</b>			
	Range	Unit	Default	Effective
	0~1000	0.01ms	40	Immed

Analog speed instruction (V-REF) is input through 1-time relay filter to smooth speed instruction. The responsiveness will be reduced if the set value is too large.

## 8.5.6 Zero-speed clamp function

This is a function used when upper controller is not configured with position loop in case of speed control.

If zero-speed clamp (ZEROSPD) (PA300.3=0) signal is set to be ON, or input voltage of speed instruction (V-REF) (PA300.3 = 1) is below PA316 (zero-speed clamp grade), servo drive is configured with position loop inside, and speed instruction is ignored and servo motor is stopped in the servo locking state. The servo motor is clamped to within  $\pm 1$  pulse at the position where zero-speed clamp is effective, and it will return to the zero-speed clamp position even if turned by external force.

Parameter	Meaning
PA300	<b>Speed control switch 1: speed dead zone control</b>
	PA300.3=0: use input signal ZEROSPD
	PA300.3=1: automatic, use PA316 setting

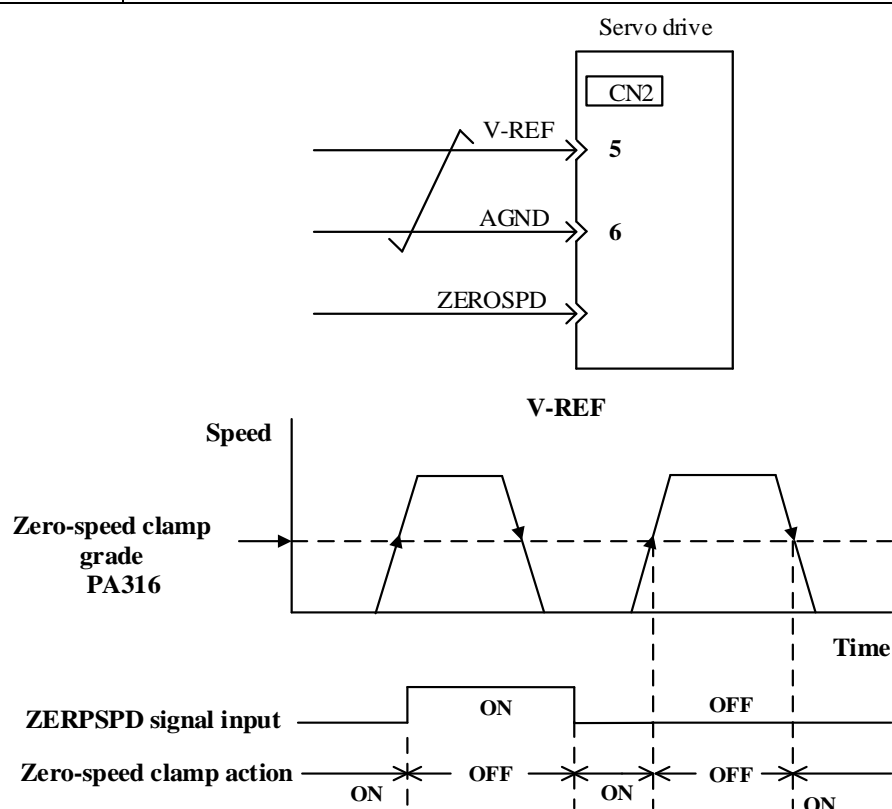

PA316	Zero-speed clamp grade			
	Range	Unit	Default	Effective
	1~2000	1rpm	30	Immed

This is to set the motor into automatic zero-speed clamp state when speed is lower than PA316 setting. PA316 should be lower than maximum motor speed.

Type	Signal	Pin	Level	Name
Input	ZEROSPD	To be allocated	ON=L level	Zero-speed clamp function ON
			OFF=H level	Zero-speed clamp function OFF

Please refer to 3.4.3 Allocation of I/O signals.

## 8.5.7 Encoder signal output

Pulse feedbacks from the encoder are processed inside the servo drive before outputting to the upper controller.

Type	Signal	Pin	Name
Output	PAO	CN2-21	Encoder Output A Phase
	/PAO	CN2-22	Encoder Output /A Phase
Output	PBO	CN2-25	Encoder Output B Phase
	/PBO	CN2-23	Encoder Output /B Phase
Output	PZO	CN2-13	Encoder Output Z Phase (reference point)
	/PZO	CN2-24	Encoder Output /Z Phase (reference point)

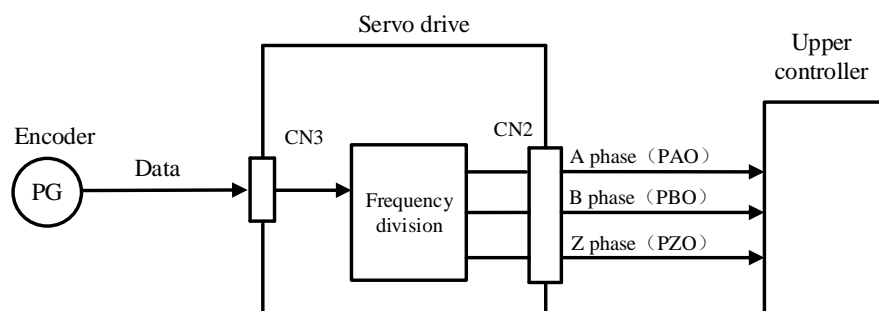

### ▪ Output phase status

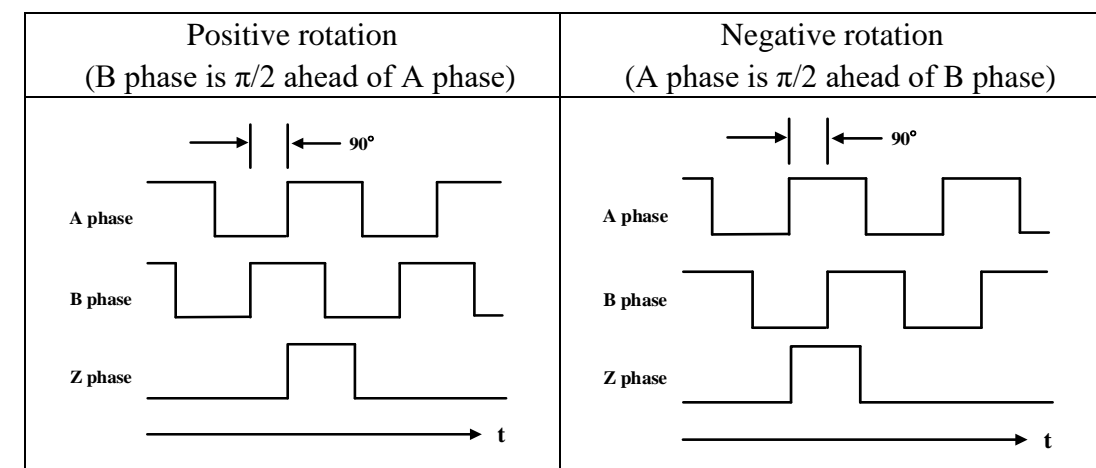

Please make servo drive rotate by two turns before using servo drive's Z phase pulse output for mechanical reference point reset action. If this can't be done due to the structure of the mechanical system, please implement reference point reset action at speed below 600rpm (calculated according to servo motor's rotating speed).

- **Frequency division**

This is a transformation process of the encoder pulse feedbacks by changing the density of pulses. The parameter is PA210.

- **Encoder resolution (frequency-division) setting**

PA210	Encoder resolution (frequency-division) setting			
	Range	Unit	Default	Effective
	16~16384	1Pulse/ rev	16384	Immed

The setting range is dependent on the encoder resolution.

Encoder specification	Resolution	Pulse per revolution	Range
Line-saving encoder	20000	5000ppr	16~5000
17-bit	131072	32768ppr	16~16384

- **Example: PA210=16**

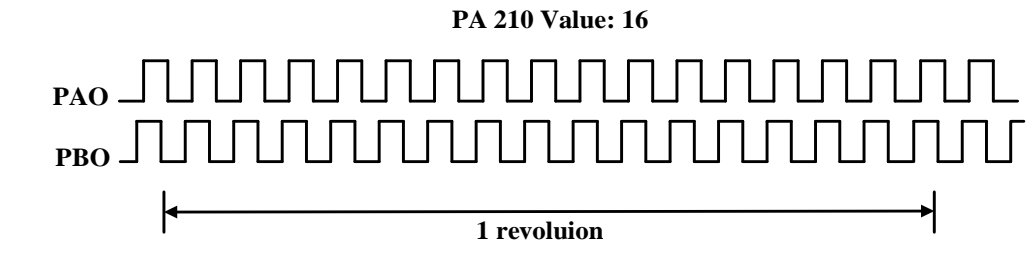

### 8.5.8 Speed instruction reached (VCMP)

When motor rotation speed is same as speed instruction, VCMP will output

Type	Signal	Pin	Level	Name
Output	VCMP	To be allocated	ON=L level	Same speed
			OFF=H level	Not same speed

VCMP needs to be allocated by PA510. Please refer to 3.4.3 Allocation of I/O signals.

PA517	VCMP signal detection width			
	Range	Unit	Default	Effective
	0~100	rpm	10	Immed

If the difference between motor speed and instruction speed is less than PA517 value, VCMP will output.

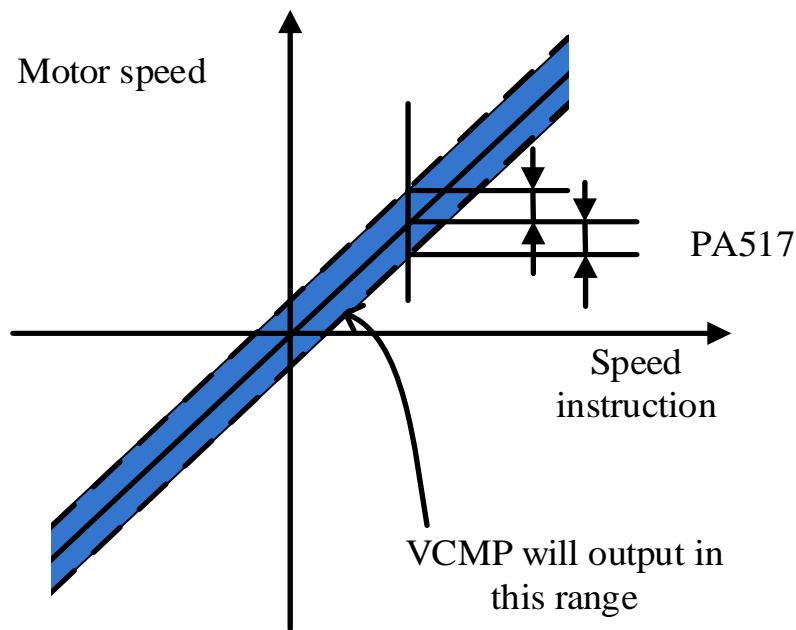

For example, PA517=100, speed instruction is 200rpm, if motor speed is within 1900rpm to 2100rpm, VCMP will be ON.

## 8.6 Torque control operations

### 8.6.1 Parameter settings

When using analog instructions for torque control, following parameters need to be set:

Parameter		Meaning
PA000	h.□□2□	Control mode selection: torque control

PA400	Torque instruction gain			
	Range	Unit	Default	Effective
	10~100	0.1V/ rated torque	30	Immed

This parameter is for setting the instruction voltage (T-REF) at motor rated torque.

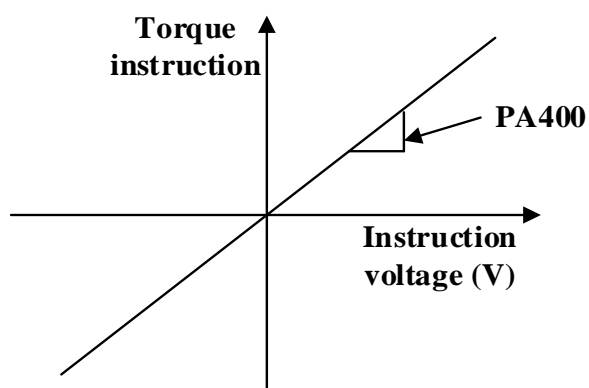

#### ▪ Examples

PA400=30: Input 3VDC will output rated torque (Default)

PA400=100: Input 10VDC will output rated torque

PA400= 20: Input 2VDC will output rated torque

## 8.6.2 Input signals

If speed instruction is sent to the servo drive, servo motor will run at a speed proportional to input voltage.

Type	Signal	Pin	Name
Input	T-REF	CN2-18	Torque instruction input
	AGND	CN2-19	GND for torque instruction input

When PA000.1 = 2, 6, 8, 9, torque control is being used.

**Input voltage range: DC  $\pm 2V \sim \pm 10V$  / rated torque**

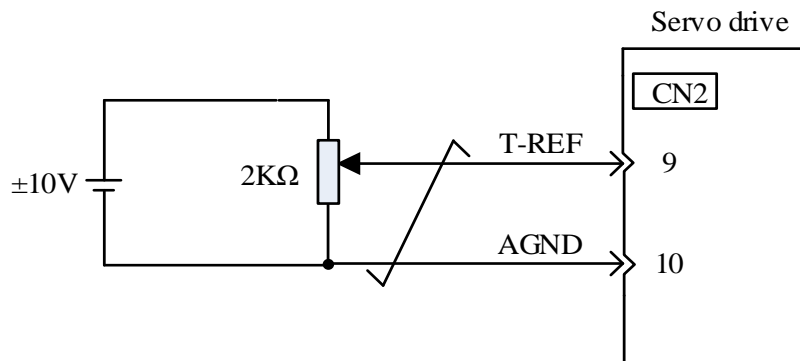
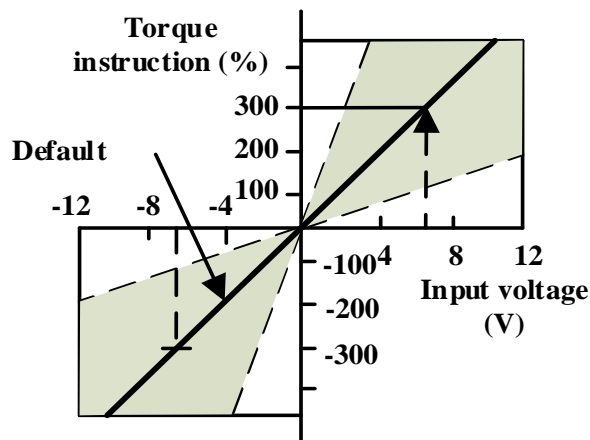

dP 10 is for Internal torque instruction (value in relation to the rated torque) display in internal torque instruction in torque / speed / position control modes.

### 8.6.3 Instruction offset adjustment

When in torque control mode, even with 0V instruction, the motor may still output at a slight torque. This happens when instruction voltage of upper controller or external circuit has slight (mV unit) deviation (offset). In this case, instruction offset can be adjusted automatically or manually by using the panel operator. Please use automatic or manual offset adjust by referring to Chapter 6.8 & 6.10.

Automatic offset adjustment is the function of offset measuring and automatic voltage adjustment. When the voltage instruction of upper controller and external circuit is deviated, the servo drive will adjust the offset automatically as follows:

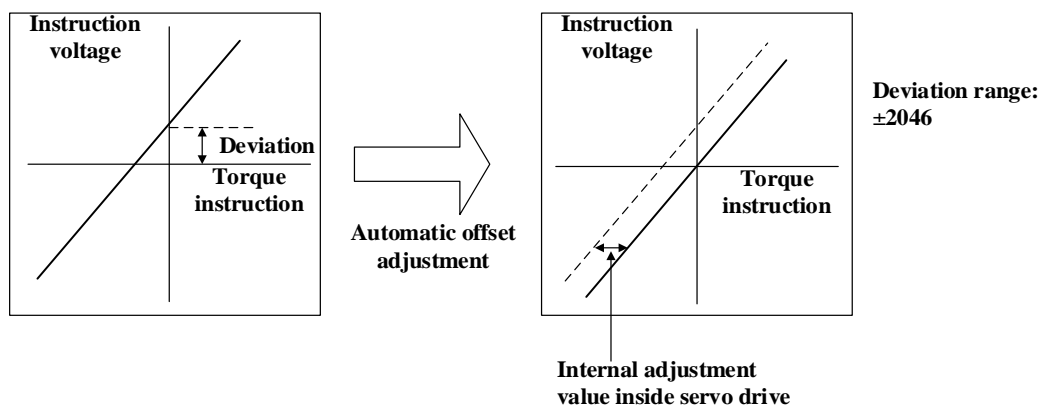

#### 1) Analog instruction automatic offset adjustment (AF 06)

Please refer to Chapter 6.8.

#### 2) Torque instruction manual offset adjustment (AF 08)

Use AF 08 in following situations (Please refer to Chapter 6.10) :

- When servo is locked and deviation pulse is set to 0, AF 06 can't be used.
- When user wants to set offset to a certain value;
- When the offset value is confirmed by AF 06.

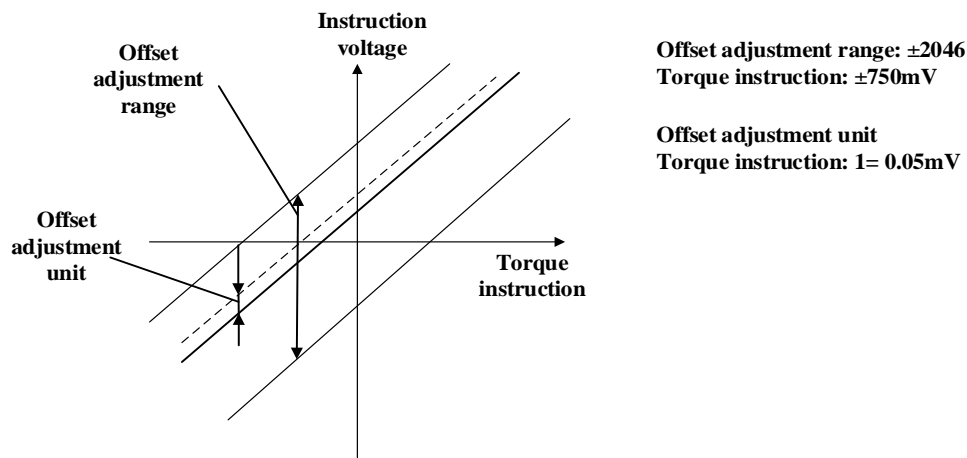



## 8.6.4 Speed limit in torque control mode

When servo motor needs to be output torque following torque instructions, motor's rotating speed is not controlled. If instruction torque is too large due to the load torque at mechanical side, motor's rotating speed may increase too much. As a protection measure at mechanical side, servo motor's rotating speed needs to have limits in torque control mode.

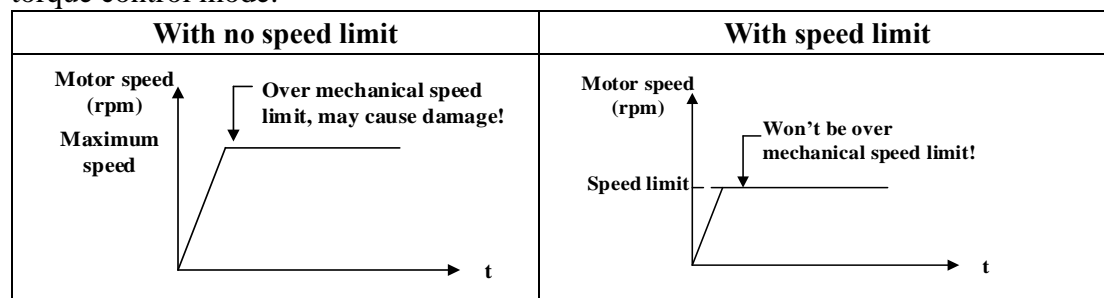

### ▪ Speed limit in torque control mode selection

Parameter	Meaning
PA002	d.□□0□ Use PA407 as speed limit (internal speed limit)
	d.□□1□ Use V-REF & PA301 setting as speed limit (external speed limit)

### ▪ Speed limit in torque control mode

PA407	Speed limit in torque control mode			
	Range	Unit	Default	Effective
	0~5000	rpm	1500	Immed

When PA002.1=0, settings of this parameter is effective.  
Value of PA407 shall not exceed maximum motor speed.

### ▪ External speed limit

Type	Signal	Pin	Name
Input	V-REF	CN2-5	External speed limit
	AGND	CN2-6	GND for external speed limit

PA301 setting has no polarity.

PA301	Speed instruction gain			
	Range	Unit	Default	Effective
	150~3000	0.01 V/rated speed	600	Immed

### ▪ Output signal when speed is in limit

Type	Signal	Pin	Level	Name
Output	VLT+	To be allocated	ON=L level	In speed limit status
	VLT-	To be allocated	OFF=H level	Not in speed limit status

*This signal is temporarily unavailable.*

## 8.7 Internal speed control

Internal speed control is to set 8 speeds beforehand through parameters inside servo drive and to select among them by using external input signals INSPD2, INSPD1 and INSPD0.

It's unnecessary to configure speed generator or pulse generator outside.

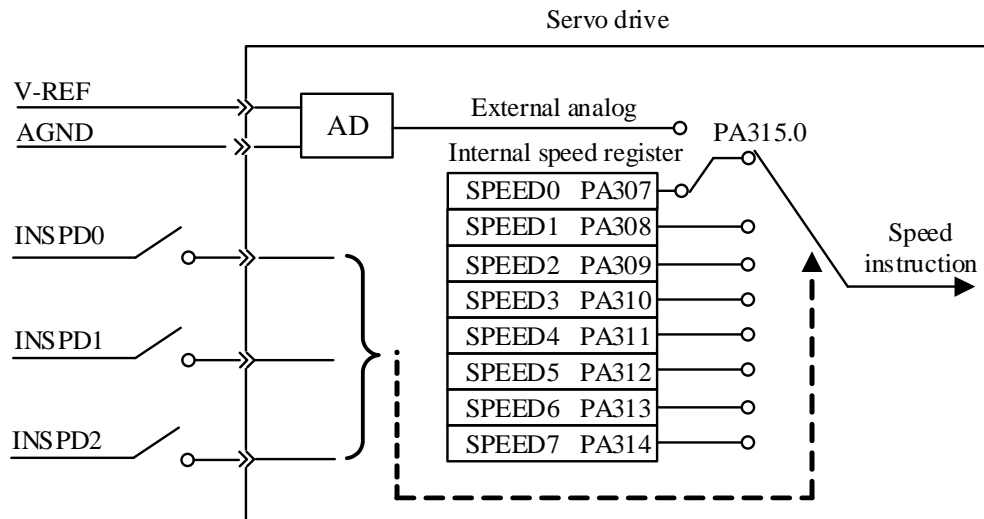

INSPD2	INSPD1	INSPD0	Internal speed selection
0 (Invalid)	0 (Invalid)	0 (Invalid)	Internal speed 0 (PA307)
0 (Invalid)	0 (Invalid)	1 (Valid)	Internal speed 1 (PA308)
0 (Invalid)	1 (Valid)	0 (Invalid)	Internal speed 2 (PA309)
0 (Invalid)	1 (Valid)	1 (Valid)	Internal speed 3 (PA310)
1 (Valid)	0 (Invalid)	0 (Invalid)	Internal speed 4 (PA311)
1 (Valid)	0 (Invalid)	1 (Valid)	Internal speed 5 (PA312)
1 (Valid)	1 (Valid)	0 (Invalid)	Internal speed 6 (PA313)
1 (Valid)	1 (Valid)	1 (Valid)	Internal speed 7 (PA314)

## 8.7.1 Parameter settings

Parameter		Meaning		
PA000	h. □□3□	Control mode selection: internal speed control		
PA307	<b>Internal speed 0</b>			
	Range	Unit	Default	Effective
	−5000~5000	rpm	100	Immed
PA308	<b>Internal speed 1</b>			
	Range	Unit	Default	Effective
	−5000~5000	rpm	200	Immed
PA309	<b>Internal speed 2</b>			
	Range	Unit	Default	Effective
	−5000~5000	rpm	300	Immed
PA310	<b>Internal speed 3</b>			
	Range	Unit	Default	Effective
	−5000~5000	rpm	400	Immed
PA311	<b>Internal speed 4</b>			
	Range	Unit	Default	Effective
	−5000~5000	rpm	500	Immed
PA312	<b>Internal speed 5</b>			
	Range	Unit	Default	Effective
	−5000~5000	rpm	600	Immed
PA313	<b>Internal speed 6</b>			
	Range	Unit	Default	Effective
	−5000~5000	rpm	700	Immed
PA314	<b>Internal speed 7</b>			
	Range	Unit	Default	Effective
	−5000~5000	rpm	800	Immed

PA307~PA314 settings should not exceed maximum motor speed.

## 8.7.2 Input signals

Type	Signal	Pin	Definitions
Input	INSPD0	To be allocated	Internal speed register 0
	INSPD1	To be allocated	Internal speed register 1
	INSPD2	To be allocated	Internal speed register 2

Please refer to 3.4.3 Allocation of I/O signals.

## 8.8 Internal position control

When **PA000.1=A**, servo drive is in internal position mode and can perform simple single-axis motions without upper controllers.

Up to 16 positions can be set. Each position can set its own distance, speed, acceleration/deceleration time, stop (dead zone) time etc. This internal position control mode also has homing function (look for zero point).

### ■ Internal position control switches & selections (PA700, PA770)

- 1) Use external INPOS0, INPOS1, INPOS2, INPOS3 to choose certain positions. Triggers can be set by PA770.1: external I/O (PTRG) or INPOS0, INPOS1, INPOS2, INPOS3.
- 2) Use external I/O (PTRG) to trigger cycle run. Cycle begins with PA700.2 and ends with PA700.3.
- 3) Internal position runs in cycles at internal timing. Cycle begins with PA700.2 and ends with PA700.3.

### ■ Internal position distance settings (PA701 to PA732)

Each distance is set by two parameters in pairs, for example, PA701 & PA702, PA703 & PA704 etc. Values in these paired parameters are hexadecimal, with symbols and combine to a 32-bit position data.

For example, PA702 is 0x 0007, PA701 is 0x A120, then position data is 0x0007A120, means 500000 pulses. For a 5000-line encoder, each turn creates 20,000 pulses. Thus the position data means 25 turns.

Notes:

- 1) Setting range is [0x0000, 0xFFFF].
- 2) Electronic gear ratio settings will have counter-effect on distance.
- 3) These parameters can also be set by communications. (Refer to Chapter 10)

### ■ Internal position speeds (PA733 to PA748)

Electronic gear ratio will have counter-effect on speeds.

### ■ Internal position acceleration/deceleration time (PA749 to PA764)

For settings please refer to Chapter 8.4.4.

### ■ Internal position stop (dead zone) time (PA765)

This parameter is only valid when PA700.0=2. (Internal position runs in cycles at internal timing)

This is time between CMD\_OK (internal position control position instruction completion signal output) and the execution of next action.

## 8.8.1 Parameter settings

Parameter		Meaning			
PA000	h.□□A□	Control mode selection: internal position control			
Parameter		Meaning			
PA700	h.□□□0	INPOS selects internal position section.			
	h.□□□1	PTRG triggers internal position run and in cycle.			
	h.□□□2	Internal position runs in cycles at internal timing.			
	h.□□0□	Incremental position			
	h.□□1□	Absolute position			
	h.□X□□	Cycle run starting position			
	h.X□□□	Cycle run ending position			
PA701	<b>Internal position 0 distance low place</b>				
	Range	Unit	Default	Effective	
	0x0000~0xFFFF	pulse	0x4E20	Immed	
PA702	<b>Internal position 0 distance high place</b>				
	Range	Unit	Default	Effective	
	0x0000~0xFFFF	pulse	0x0000	Immed	
~~					
PA731	<b>Internal position 15 distance low place</b>				
	Range	Unit	Default	Effective	
	0x0000~0xFFFF	pulse	0xE200	Immed	
PA732	<b>Internal position 15 distance high place</b>				
	Range	Unit	Default	Effective	
	0x0000~0xFFFF	pulse	0x0004	Immed	
PA733	<b>Internal position 0 speed</b>				
	Range	Unit	Default	Effective	
	0~5000	rpm	100	Immed	
~~					
PA748	<b>Internal position 15 speed</b>				
	Range	Unit	Default	Effective	
	0~5000	rpm	100	Immed	
PA749	<b>Internal position 0 acceleration/deceleration time</b>				
	Range	Unit	Default	Effective	
	0~500	ms	0	Immed	
~~					
PA764	<b>Internal position 15 acceleration/deceleration time</b>				
	Range	Unit	Default	Effective	
	0~500	ms	0	Immed	

<b>PA765</b>	<b>Internal position dead zone time</b>			
	Range	Unit	Default	Effective
	0~65335	ms	100	Immed
<b>PA768</b>	<b>JOG speed in internal position control mode</b>			
	Range	Unit	Default	Effective
	0~5000	rpm	100	Immed

Value of PA733~PA748 shall not exceed maximum motor speed.

Parameter	Meaning																								
<b>PA770</b>	<p><b>Internal position control switch 2</b></p> <p>b. <input type="checkbox"/> <sup>3</sup> <input type="checkbox"/> <sup>2</sup> <input type="checkbox"/> <sup>1</sup> <input type="checkbox"/> <sup>0</sup></p> <table border="1"> <tr> <th colspan="2">Trigger signal selection</th> </tr> <tr> <td>0</td> <td>Use PTRG</td> </tr> <tr> <td>1</td> <td>Use internal position selection signals: INPOS0、INPOS1、INPOS2、INPOS3</td> </tr> </table> <table border="1"> <tr> <th colspan="2">Trigger time sequence selection</th> </tr> <tr> <td>0</td> <td>Only receive new trigger signal when current position is completed (CMD-OK)</td> </tr> <tr> <td>1</td> <td>Can receive new trigger even though current position is not completed</td> </tr> </table> <table border="1"> <tr> <th colspan="2">PZERO function selection</th> </tr> <tr> <td>0</td> <td>Stop.</td> </tr> <tr> <td>1</td> <td>Pause.</td> </tr> </table> <table border="1"> <tr> <th colspan="2">Software position limit enabling</th> </tr> <tr> <td>0</td> <td>No enabling.</td> </tr> <tr> <td>1</td> <td>Can enable. PA756, PA757 are positive limits; PA758, PA759 are negative limits.</td> </tr> </table>	Trigger signal selection		0	Use PTRG	1	Use internal position selection signals: INPOS0、INPOS1、INPOS2、INPOS3	Trigger time sequence selection		0	Only receive new trigger signal when current position is completed (CMD-OK)	1	Can receive new trigger even though current position is not completed	PZERO function selection		0	Stop.	1	Pause.	Software position limit enabling		0	No enabling.	1	Can enable. PA756, PA757 are positive limits; PA758, PA759 are negative limits.
Trigger signal selection																									
0	Use PTRG																								
1	Use internal position selection signals: INPOS0、INPOS1、INPOS2、INPOS3																								
Trigger time sequence selection																									
0	Only receive new trigger signal when current position is completed (CMD-OK)																								
1	Can receive new trigger even though current position is not completed																								
PZERO function selection																									
0	Stop.																								
1	Pause.																								
Software position limit enabling																									
0	No enabling.																								
1	Can enable. PA756, PA757 are positive limits; PA758, PA759 are negative limits.																								

## 8.8.2 Input signals

Type	Signal	Pin	Level	Meaning
Input	ZPS	To be allocated	ON=L level	External zero switch signal ON
			OFF=H level	External zero switch signal OFF
	PZERO	To be allocated	ON=L level	Internal position control stops: valid
			OFF=H level	Internal position control stops: invalid
	INPOS0	To be allocated	ON=L level	INPOS0 signal valid
			OFF=H level	INPOS0 signal invalid
	INPOS1	To be allocated	ON=L level	INPOS1 signal valid
			OFF=H level	INPOS1 signal invalid
	INPOS2	To be allocated	ON=L level	INPOS2 signal valid
			OFF=H level	INPOS2 signal invalid
	INPOS3	To be allocated	ON=L level	INPOS3 signal valid
			OFF=H level	INPOS3 signal invalid
	PTRG	To be allocated	OFF (H level) to ON (L level)	PTRG signal valid
	P-POS	To be allocated	ON=L level	P-POS signal valid
			OFF=H level	P-POS signal invalid
	N-POS	To be allocated	ON=L level	N-POS signal valid
OFF=H level			N-POS signal invalid	
SHOME	To be allocated	OFF (H level) to ON (L level)	SHOME signal valid	

Please refer to 3.4.3 Allocation of I/O signals.

### ■ External zero switch signal (ZPS)

Used for homing functions only. Please refer to Chapter 8.9.

### ■ Internal position control stops (PZERO)

When PZERO is valid in internal position control, the motor stops and stays in clamping status. PA770.2 can select whether this is a stop or pause.

If PA770.2=0 (stop), homing process needs to restart after PZERO becomes invalid again.

If PA770.2=1 (pause), homing process will continue after PZERO becomes invalid again.

■ Internal position register (INPOS0、INPOS1、INPOS2、INPOS3)

INPOS0, INPOS1, INPOS2, INPOS3 combines to achieve 16-position control

INPOS3	INPOS2	INPOS1	INPOS0	Internal position selection
0 (invalid)	0 (invalid)	0 (invalid)	0 (invalid)	Position 0 (PA702&PA701)
0 (invalid)	0 (invalid)	0 (invalid)	1 (valid)	Position 1 (PA704&PA703)
0 (invalid)	0 (invalid)	1 (valid)	0 (invalid)	Position 2 (PA706&PA705)
0 (invalid)	0 (invalid)	1 (valid)	1 (valid)	Position 3 (PA708&PA707)
0 (invalid)	1 (valid)	0 (invalid)	0 (invalid)	Position 4 (PA710&PA709)
0 (invalid)	1 (valid)	0 (invalid)	1 (valid)	Position 5 (PA712&PA711)
0 (invalid)	1 (valid)	1 (valid)	0 (invalid)	Position 6 (PA714&PA713)
0 (invalid)	1 (valid)	1 (valid)	1 (valid)	Position 7 (PA716&PA715)
1 (valid)	0 (invalid)	0 (invalid)	0 (invalid)	Position 8 (PA718&PA717)
1 (valid)	0 (invalid)	0 (invalid)	1 (valid)	Position 9 (PA720&PA719)
1 (valid)	0 (invalid)	1 (valid)	0 (invalid)	Position 10 (PA722&PA721)
1 (valid)	0 (invalid)	1 (valid)	1 (valid)	Position 11 (PA724&PA723)
1 (valid)	1 (valid)	0 (invalid)	0 (invalid)	Position 12 (PA726&PA725)
1 (valid)	1 (valid)	0 (invalid)	1 (valid)	Position 13 (PA728&PA727)
1 (valid)	1 (valid)	1 (valid)	0 (invalid)	Position 14 (PA730&PA729)
1 (valid)	1 (valid)	1 (valid)	1 (valid)	Position 15 (PA732&PA731)

This is illustrated as below:

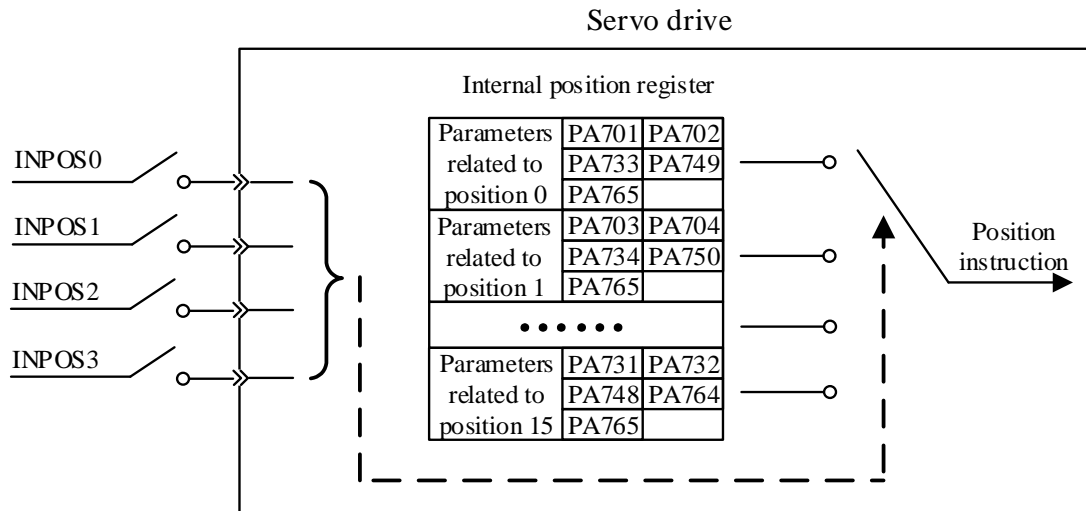



■ **Internal position control trigger (PTRG)**

When PA700.0=0 or 1, and PA770.1=0 in internal position control mode, the rising edge is valid.

Time sequence of PTRG is illustrated below:

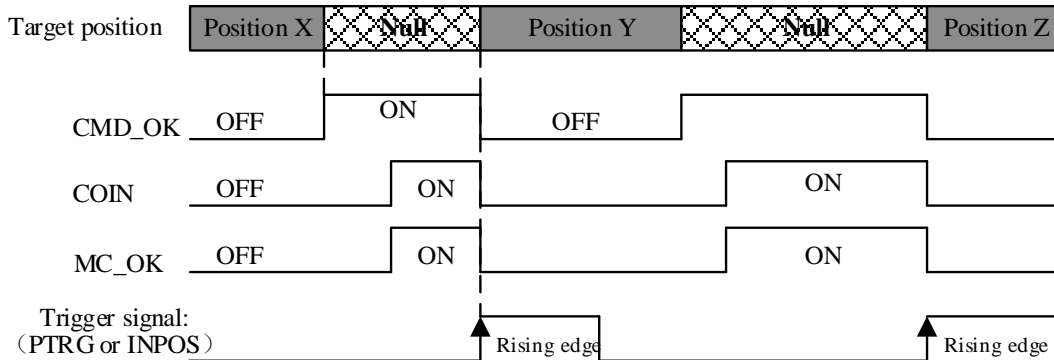

■ **Internal position control Forward JOG (P-POS)**

In internal position control mode, even during homing or internal position sections, when P-POS signal becomes valid, position instruction will cut to forward JOG immediately and all current running instructions will be canceled and the cycle run will restart to starting point. PA768 is JOG speed in internal position control mode.

■ **Internal position control Reverse JOG (N-POS)**

■ **Internal position control homing start (SHOME)**

In internal position control mode, when SHOME signal becomes valid, all current running instructions will be canceled to cut into homing operations. The rising edge of this signal is valid.

### 8.8.3 Output signals

Type	Signal	Pin	Status	Meaning
Output	HOME	To be allocated	Valid	Internal position control homing completed
			Invalid	Internal position control homing not completed
	CMD-OK	To be allocated	Valid	Internal position control instruction completed
			Invalid	Internal position control instruction not completed
	MC-OK	To be allocated	Valid	Internal position control positioning & command completed
			Invalid	Internal position control positioning & command not completed

Please refer to 3.4.3 Allocation of I/O signals.

#### ■ Internal position control homing completion signal (HOME)

When homing is completed, and position coordinates are valid, and position counter is valid, this signal is ON.

- This signal is OFF at power on;
- When homing is completed, this signal is ON;
- After running one position section, this signal is OFF;
- When SHOME triggers, this signal is OFF;
- When homing is completed again, this signal is ON;
- When inputting PZERO to stop homing, this signal is OFF.

#### ■ Internal position control instruction completion signal (CMD-OK)

- When entering internal position control mode, this signal is ON;
- When during instruction executing, this signal is OFF;
- When position instructions finish executing, this signal is ON.

**This signal only means the completion of instructions, not necessarily actual motor positioning.**

#### ■ Internal position control positioning & command completion (MC-OK)

This signal means both the completion of positioning & commands.

When CMD-OK & COIN are both ON, this signal is ON; otherwise OFF.

## 8.9 Homing function

Normally there should be a reference point (zero) switch on working tables and is used to determine coordinate system zero position for point-to-point controls. Homing is needed when power-on or after each processing for next movement. In internal position control mode, upper controller gives homing start (SHOME) signal and the servo drive will execute homing functions automatically. Homing modes, homing speeds and offset can all be set through PA771, PA775, PA776, PA777, and PA778.

### ■ Homing mode selections

Parameter	Meaning																				
PA771	<p>d. <input type="checkbox"/> <input type="checkbox"/> <input type="checkbox"/> <input type="checkbox"/></p> <p><b>Homing rotational direction</b></p> <table border="1"> <tr><td>0</td><td>Forward rotation</td></tr> <tr><td>1</td><td>Reverse rotation</td></tr> </table> <p><b>Homing pattern selection</b></p> <table border="1"> <tr><td>0</td><td>After contacting zero switch, look for Z pulse by rotating backward</td></tr> <tr><td>1</td><td>After contacting zero switch, look for Z pulse by rotating forward</td></tr> <tr><td>2</td><td>After contacting zero switch, rotate backward, not look for Z pulse</td></tr> <tr><td>3</td><td>After contacting zero point switch, rotate forward, not look for Z pulse</td></tr> </table> <p><b>Homing completion operation</b></p> <table border="1"> <tr><td>0</td><td>Clear all position data</td></tr> <tr><td>1</td><td>Not clear all position data</td></tr> </table> <p><b>Homing signal selection</b></p> <table border="1"> <tr><td>0</td><td>Use ZPS</td></tr> <tr><td>1</td><td>Use Z pulse</td></tr> </table>	0	Forward rotation	1	Reverse rotation	0	After contacting zero switch, look for Z pulse by rotating backward	1	After contacting zero switch, look for Z pulse by rotating forward	2	After contacting zero switch, rotate backward, not look for Z pulse	3	After contacting zero point switch, rotate forward, not look for Z pulse	0	Clear all position data	1	Not clear all position data	0	Use ZPS	1	Use Z pulse
		0	Forward rotation																		
		1	Reverse rotation																		
		0	After contacting zero switch, look for Z pulse by rotating backward																		
		1	After contacting zero switch, look for Z pulse by rotating forward																		
		2	After contacting zero switch, rotate backward, not look for Z pulse																		
		3	After contacting zero point switch, rotate forward, not look for Z pulse																		
		0	Clear all position data																		
		1	Not clear all position data																		
		0	Use ZPS																		
		1	Use Z pulse																		

### ■ Other homing parameters

PA775	<b>Homing speed before contacting zero signal</b>			
	Range	Unit	Default	Effective
	0~3000	rpm	500	Immed
PA776	<b>Homing speed after contacting zero signal</b>			
	Range	Unit	Default	Effective
	0~500	rpm	30	Immed
PA777	<b>Zero switch offset low place</b>			
	Range	Unit	Default	Effective
	0x0000~0xFFFF	pulse	0	Immed
PA778	<b>Zero switch offset high place</b>			
	Range	Unit	Default	Effective
	0x0000~0x1FFF	pulse	0	Immed

---

**Important**

- When PA775, PA776 settings exceed maximum speed of the servo motor, actual value is still restricted as servo motor's maximum speed.
  - Zero position offset directions are determined by homing directions.
  - Homing functions are suitable for internal position control (junction instruction) and position control (pulse instruction).
  - During homing, servo drive does not receive pulse commands.
- 

**■ Description of the homing process**

- When SHOME rising edge is detected, motor runs at direction set by PA771.0 and speed set by PA772.
- When zero switch (reference point) signal ZPS is detected active, motor runs at speed set by PA775 after finding Z pulse according to PA771.1 setting.
- When ZPS is inactive, also after detected Z pulse, motor runs at speed set by PA776 and starts calculating zero switch offset pulse numbers.
- When zero switch offset pulse number is reached, motor stops and outputs HOME signal.
- Normally set PA775 at high speed and PA776 at low speed. Note that if PA776 is set too high, homing accuracy will be affected.

- **PA771.1=0: After contacting zero switch, look for Z pulse by rotating backward.**

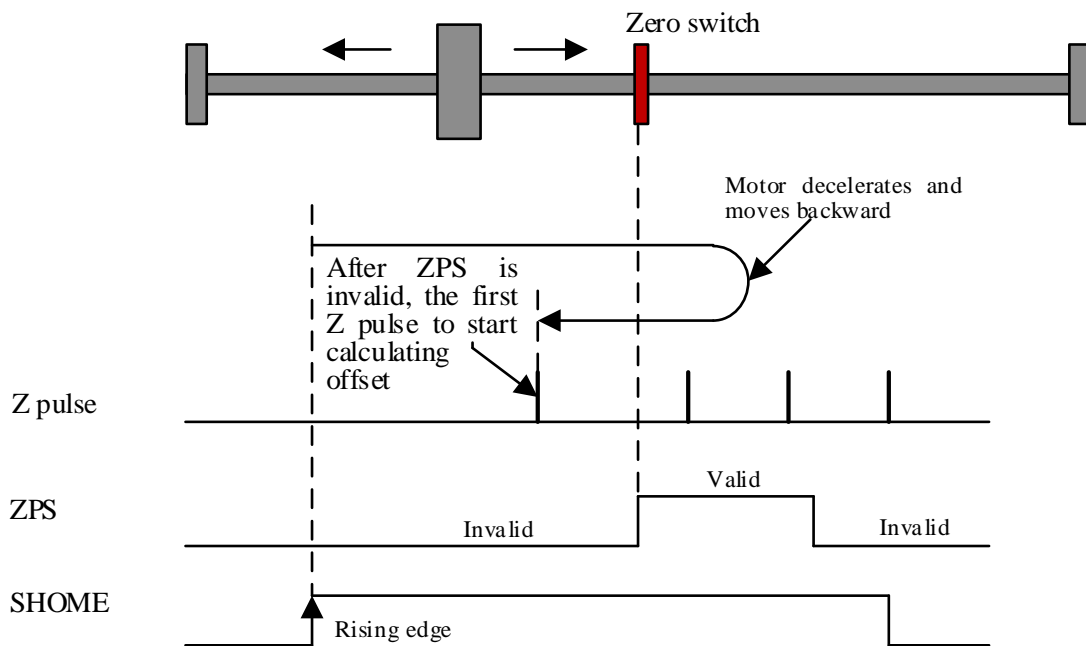
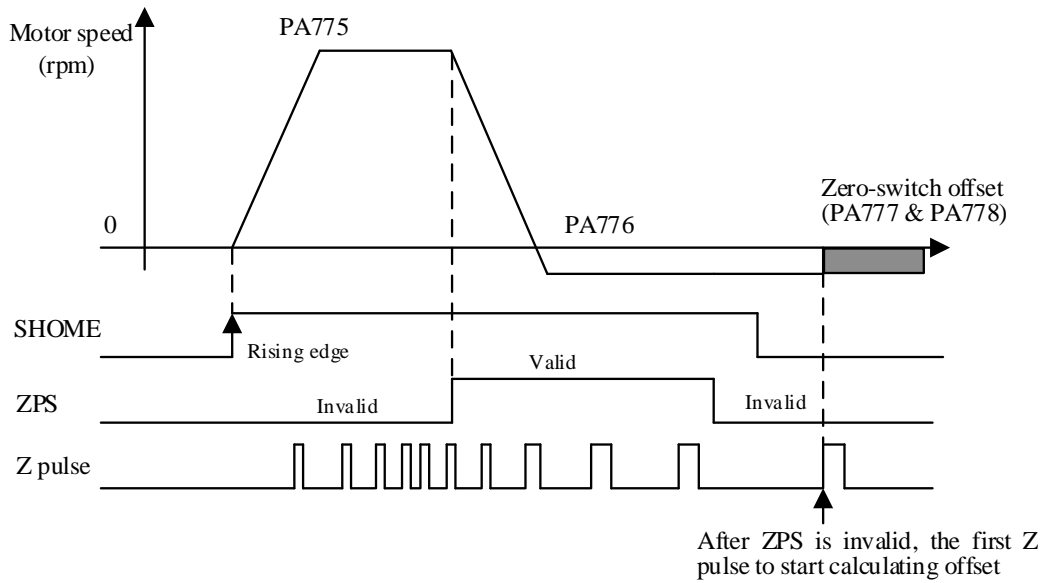

- **PA771.1=1: After contacting zero switch, look for Z pulse by rotating forward.**

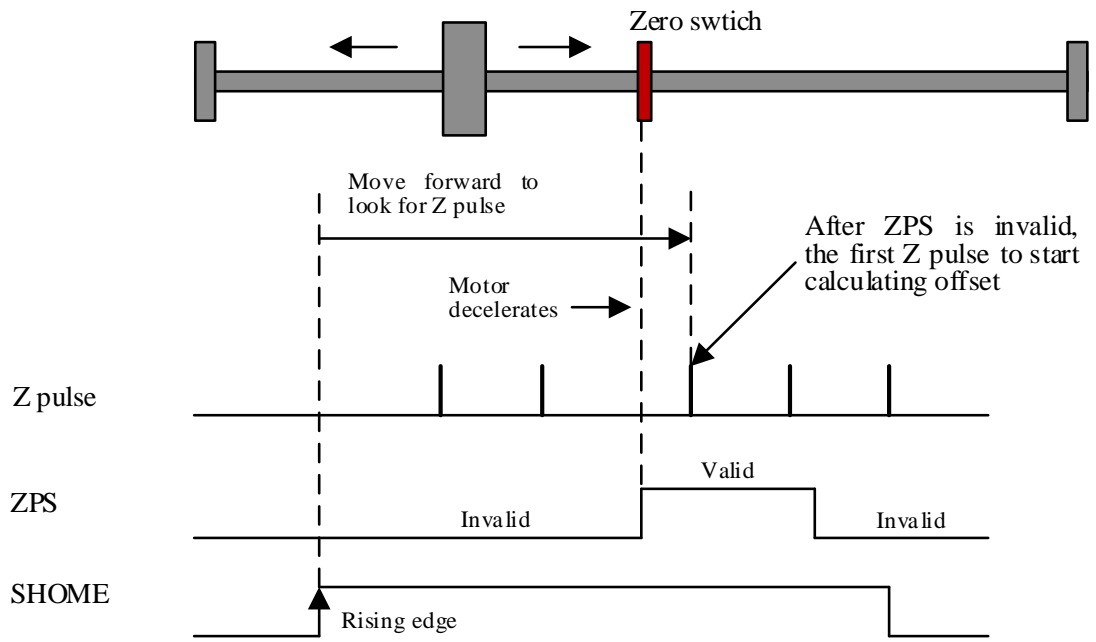
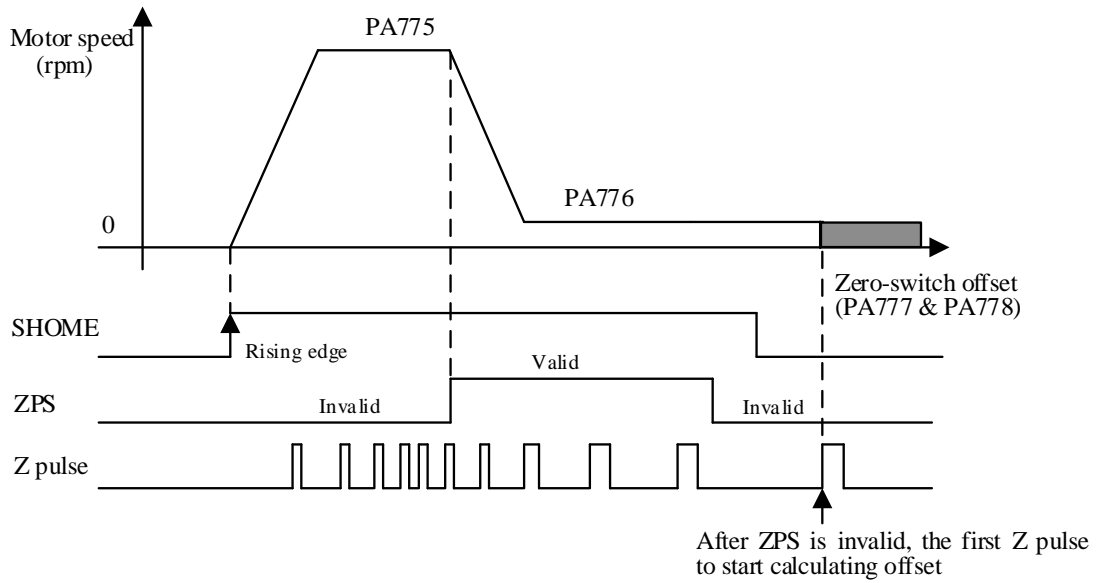

- PA771.1=2: After contacting zero switch, rotate backward, not look for Z pulse.

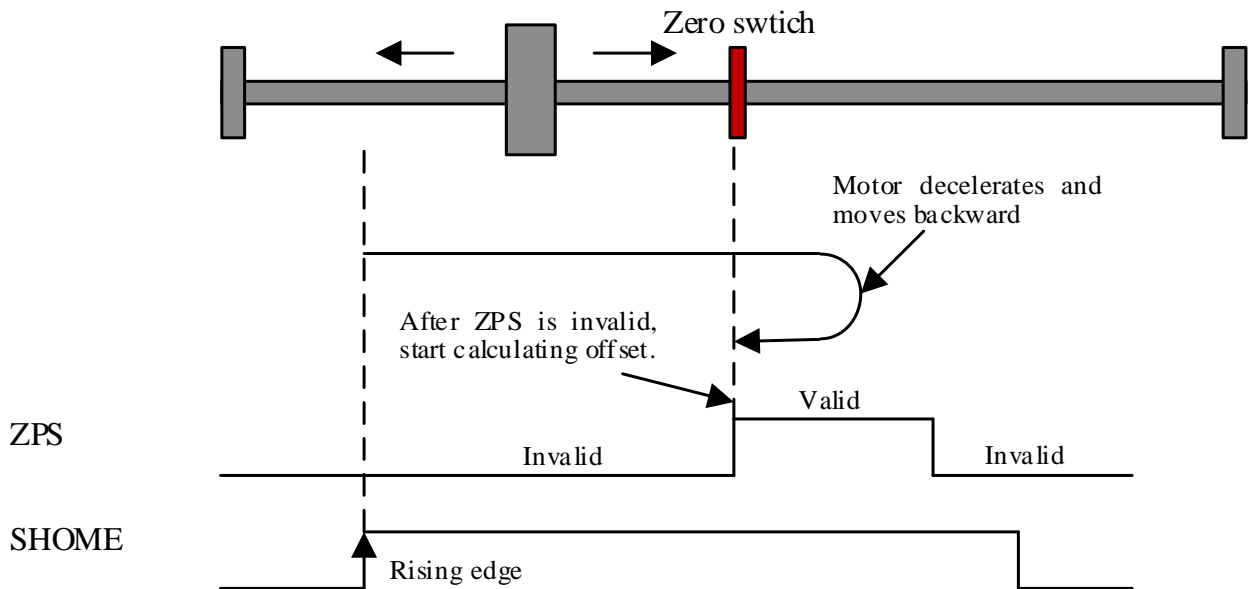
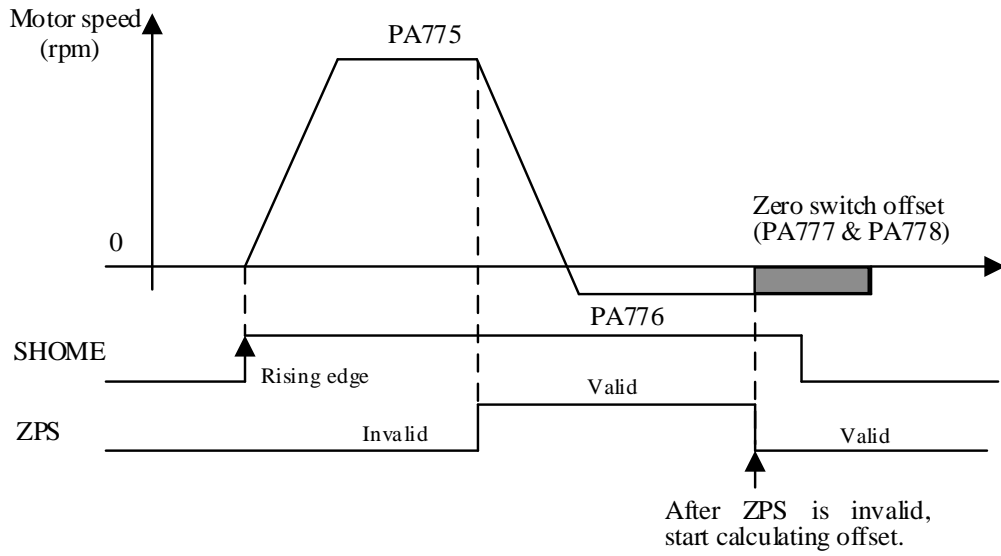

- **PA771.1=3: After contacting zero switch, rotate forward, not look for Z pulse.**

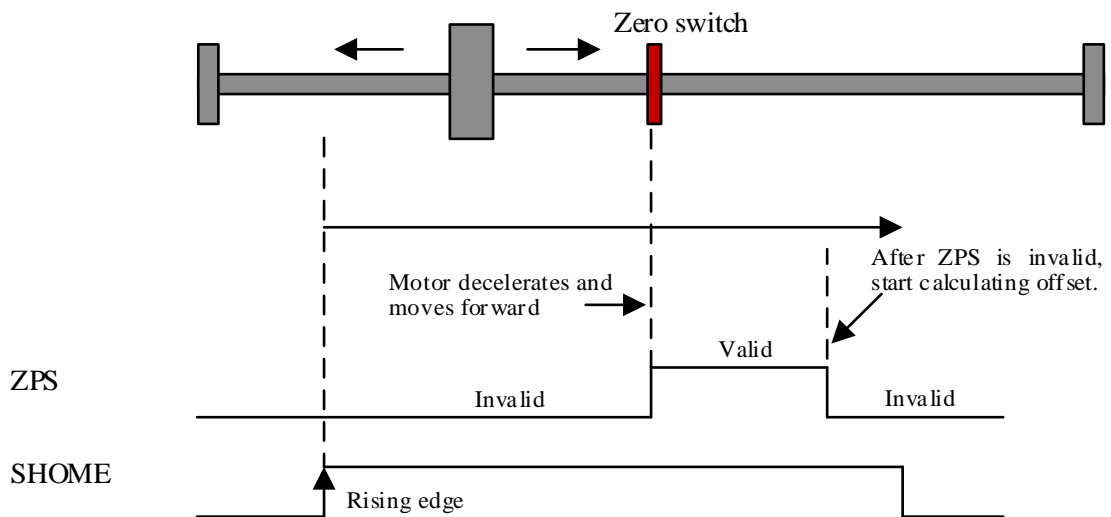
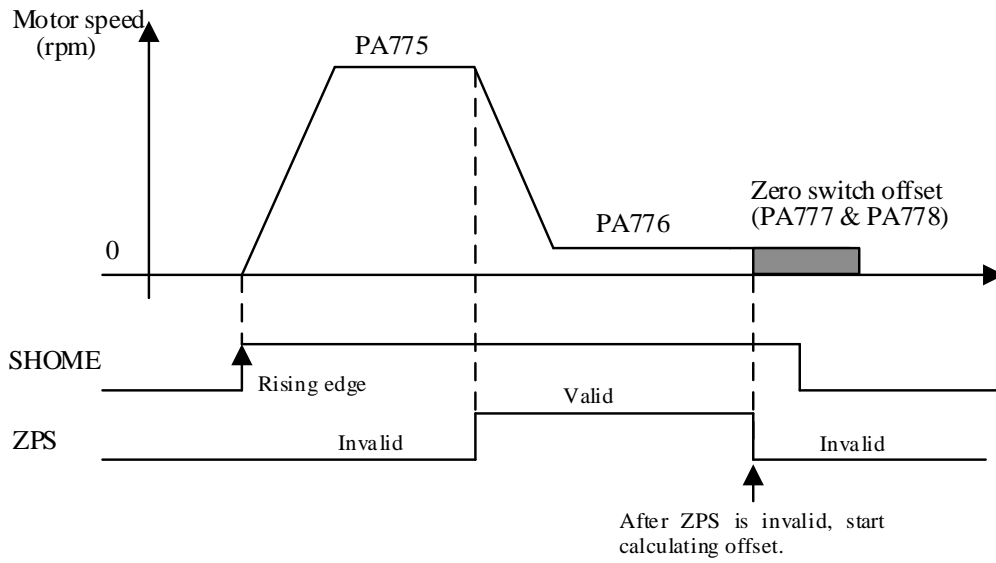



## 8.10 Combination of different control modes

The servo can select two control modes and switch between them. Settings are as below:

### 8.10.1 Parameter settings

Parameter	Control mode combinations
PA000	h.□□4□ Internal speed control ↔ Position control
	h.□□5□ Internal speed control ↔ Speed control
	h.□□6□ Internal speed control ↔ Torque control
	h.□□7□ Position control ↔ Speed control
	h.□□8□ Position control ↔ Torque control
	h.□□9□ Torque control ↔ Speed control
	h.□□B□ Internal position control ↔ Position control

### 8.10.2 Input signal

- When C-MODE is invalid, first control mode is selected;
- When C-MODE is valid, second control mode is selected

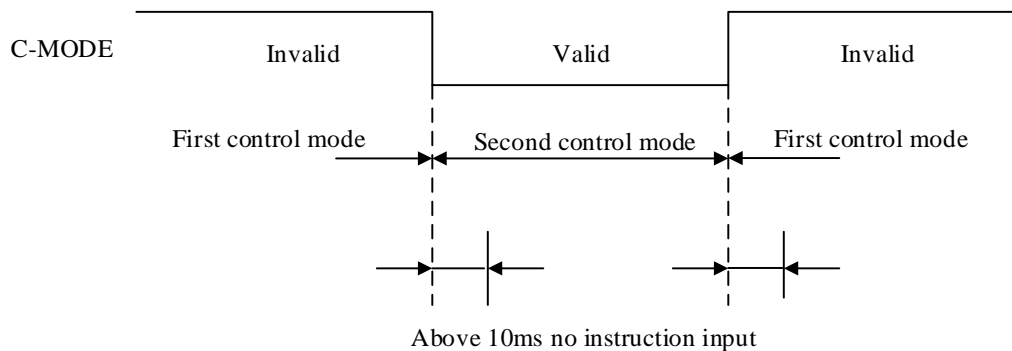

# Chapter 9 Fault diagnosis

## 9.1 Alarms

Code	Symptom/Cause	Clear	Solutions
E.03	Wrong parameters & verifications	No	AF 05: parameter initialization.
E.04	Wrong parameter data format	No	AF 05: parameter initialization.
E.05	Abnormal internal circuit of current detection channel 1	No	Power off, then power on again after 1 minute.
E.06	Abnormal internal circuit of current detection channel 2	No	Power off, then power on again after 1 minute.
E.08	Servo drive internal communication error	No	1) Power off, then power on again after 1 minute; 2) Check motor earthing and whether next to interference source.
E.10	Broken encode line	No	1) Check encoder line; 2) Check if PA002.3 matches encoder type.
E.11	Encoder A/B pulse loss	No	1) Check encoder line; 2) Check grounding of both servo drive and motor; 3) Check shielding cable connections; 4) Separate encoder line from power supply cables.
E.12	Encoder Z pulse loss	No	Check encoder line.
E.13	Encoder UVW error	No	Check encoder line.
E.14	Encoder status error	No	Check encoder line.
E.15	Main power supply wiring error	No	1) Check if there is input phase loss; 2) Check if input voltage is correct; 3) Set PA001.2=1.
E.16	Regenerative circuit error	No	1) Check if input voltage is too low; 2) Set PA009.0=1 to disable this alarm.
E.17	Regenerative resistor error	No	1) Check if input voltage is too low; 2) Set PA009.0=1 to disable this alarm; 3) Check if regenerative resistor is already connector or if has error.
E.18	(Main circuit DC bus) under-voltage	No	1) Check if input voltage is correct; 2) Check if the relay works properly (should have sound when power on) ; 3) Increase value of PA512.
E.19	(Main circuit DC bus)	No	1) Check if input voltage is correct;

	over-voltage		<ul style="list-style-type: none"> <li>2) Check regenerative resistor;</li> <li>3) Reduce the value of PA512.</li> </ul>
E.20	IGBT alarm	No	<ul style="list-style-type: none"> <li>1) Check if drive matches motor (PA012) ;</li> <li>2) Reduce the value of PA402 &amp; PA403;</li> <li>3) Increase the value of PA104.</li> </ul>
E.21	Motor overload	Yes	<ul style="list-style-type: none"> <li>1) Increase the value of PA010.3;</li> <li>2) Increase acceleration/deceleration time (Position control: reduce PA100, increase PA214, PA215, PA216. Speed control: increase PA302, PA303, PA304) ;</li> <li>3) Reduce the value of PA402 &amp; PA403;</li> <li>4) Change to a higher power servo.</li> </ul>
E.22	Regenerative overload	Yes	<ul style="list-style-type: none"> <li>1) Increase acceleration/deceleration time (Position control: reduce PA100, increase PA214, PA215, PA216. Speed control: increase PA302, PA303, PA304) ;</li> <li>2) Increase PA010.2 if the resistor can withstand;</li> <li>3) Increase value of PA512.</li> </ul>
E.23	DB overload	Yes	
E.25	Deviation counter overflow (exceeds 256*65536)	Yes	<ul style="list-style-type: none"> <li>1) Check if motor can JOG properly;</li> <li>2) Check electronic gear ratio settings;</li> <li>3) Check if torque limit is correct;</li> <li>4) Check if there is limit switch.</li> </ul>
E.26	Position deviation exceeds setting value of PA528	Yes	<ul style="list-style-type: none"> <li>1) Check if motor can JOG properly;</li> <li>2) Check electronic gear ratio settings;</li> <li>3) Increase PA528;</li> <li>4) Check if there is limit switch.</li> </ul>
E.27	Motor speed exceeds maximum speed*1.2	Yes	<ul style="list-style-type: none"> <li>1) Check if motor UVW wirings are correct;</li> <li>2) Check if the PID parameters are correct or if load inertia is too high;</li> <li>3) Increase acceleration/deceleration time (Position control: reduce PA100, increase PA214, PA215, PA216. Speed control: increase PA302, PA303, PA304).</li> </ul>
E.28	Motor speed out of control	Yes	<ul style="list-style-type: none"> <li>1) Check if motor UVW wirings are correct;</li> <li>2) Check PID settings for responsiveness;</li> <li>3) Increase PA530 (if too high will disable the protection function).</li> </ul>
E.29	Motor out of control	Yes	<ul style="list-style-type: none"> <li>1) Check if motor UVW wirings are correct;</li> <li>2) Check if encoder type is correct (PA002.3) ;</li> <li>3) Check if drive matches motor (PA012) ;</li> <li>4) Reduce servo gains properly, such as increase filter (PA215, PA216).</li> </ul>
E.30	Electronic gear ratio value	Yes	<ul style="list-style-type: none"> <li>1) Check electronic gear ratio settings;</li> </ul>

	too high		2) Check input pulse frequency.
E.31	Internal data value too high: calculation is over 32-bit	Yes	1) Check electronic gear ratio settings; 2) Check input pulse frequency.
E.35	Input inhabitation	Yes	1) Check if there is limit switch signal input; 2) Set PA003.2=1 to disable this alarm.
E.36	Fully closed loop deviation too large	Yes	
E.44	Servo drive reset error	No	1) Time interval between power off & power on again shall be greater than 5 seconds; 2) Check if there is any interference source nearby.
E.45	Servo drive internal error 1	No	
E.46	Servo drive internal error 2	No	
E.47	Servo drive internal error 3	No	
E.50	17-bit serial encoder communicational error	No	1) Check if PA002.3 matches encoder type; 2) Check encoder line; 3) Replace the servo motor.
E.51	17-bit serial encoder ODD/EVEN place, stop place verification error	Yes	1) Check encoder line; 2) Check if there is any interference source nearby; 3) Check shielding wire connections; 4) Replace the servo motor;
E.52	17-bit serial encoder data verification error	Yes	Same as above.
E.53	17-bit serial encoder status domain stop place error	Yes	Same as above.
E.54	17-bit serial encoder SFOME stop place error	Yes	Same as above.
E.55	17-bit serial encoder over-speed	Yes	1) Check if motor axis displaced during power off; 2) Execute AF 12; 3) Check if absolute encoder has battery.
E.56	17-bit serial encoder absolute status error	Yes	1) Check if there is any interference source nearby; 2) Execute AF 11.
E.57	17-bit serial encoder counter error	Yes	1) Check if there is any interference source nearby; 2) Execute AF 11.
E.58	17-bit serial encoder multi-turn data overflow (exceeds 65535 turns)	Yes	1) Check if there is any interference source nearby; 2) Execute AF 11.
E.59	17-bit serial encoder over-heat	Yes	1) Check motor temperature; 2) Execute AF 12.

E.60	17-bit serial encoder multi-turn data error	Yes	1) Check battery voltage; 2) Execute AF 11.
E.61	17-bit serial encoder battery voltage less than 3.1V	Yes	1) Replace battery; 2) Execute AF 12
E.62	17-bit serial encoder battery voltage less than 2.5V	No	Same as above
E.63	17-bit serial encoder data not initialized	Yes	1) Check if PA002.3 matches encoder type; 2) Initialize 17-bit serial encoder.
E.64	17-bit serial encoder data & verification error	Yes	Same as above
E.67	Servo drive does not match the servo motor	Yes	1) Modify PA012 setting; 2) Disable this alarm by PA007.3 but may degrade motor performance or cause E.29; 3) Replace the servo drive or motor.
E.68	Same as above	Yes	Same as above
E.69	Same as above	Yes	Same as above
E.70	Absolute encoder data error	Yes	
E.76	IGBT over-heat	Yes	1) Check servo drive fan; 2) Check ventilation; 3) Set PA009.2=0 to disable this alarm.
E.77	Software limit switch alarm	Yes	1) Check if PA779~PA782 are correct; 2) Set PA770.3=0 to disable this alarm.

## 9.2 Warnings

Code	Symptom/Cause	Solutions
A.90	Position deviation (residual pulse) too much	<ol style="list-style-type: none"> <li>1) Check electronic gear ratio settings;</li> <li>2) Increase PA527;</li> <li>3) Check if there is limit switch.</li> </ol>
A.91	Overload	<ol style="list-style-type: none"> <li>1) Increase acceleration/deceleration time;</li> <li>2) Increase stop/start times;</li> <li>3) Increase PA010.3;</li> <li>4) Reduce load;</li> <li>5) Replace with a higher power servo.</li> </ol>
A.92	Regenerative overload	<ol style="list-style-type: none"> <li>1) Increase acceleration/deceleration time;</li> <li>2) Increase stop/start times;</li> <li>3) Increase PA010.2;</li> <li>4) Use a regenerative resistor with higher power but lower resistance</li> </ol>
A.95	Over-voltage warning	<ol style="list-style-type: none"> <li>1) Increase acceleration/deceleration time;</li> <li>2) Increase stop/start times;</li> <li>3) Reduce regenerative resistance;</li> <li>4) Reduce PA512.</li> </ol>
A.96	Under-voltage warning	<ol style="list-style-type: none"> <li>1) Check input voltage;</li> <li>2) Increase PA512.</li> </ol>
A.97	17-bit serial encoder battery voltage less than 3.1V	<ol style="list-style-type: none"> <li>1) Check battery voltage and wiring;</li> <li>2) Replace battery.</li> </ol>

# Chapter 10 Communications

## 10.1 Communication terminals

Please refer to chapter 3.3 for wirings of CN1.

- 1) If upper controller only connects to one servo drive, connect RJ45 (1) to upper controller and RJ45 (2) to a 120Ω resistor.
- 2) If upper controller connects to multiple servo drives, connect RJ45 (1) of first servo drive to upper controller and RJ45 (2) of first servo drive to RJ45 (1) of second servo drive. Connect all servo drives in this way and connect RJ45 (2) of last servo drive to a 120Ω resistor.
- 3) Do not connect pin 4 or pin 5 of RJ45.

## 10.2 Communication parameters

Parameter	Name	Range	Unit	Default	Effective																					
PA015	RS485 communication address	1~31		1	Immed																					
	RS485 communication function selection	d.0000~0095		d.0095	Immed																					
PA016	<p>The diagram shows four bits labeled 3, 2, 1, and 0. Bit 3 is connected to the 'RS485 bit rate' table. Bit 2 is connected to the 'Communicational protocol' table. Bit 1 is connected to the 'Reserved' table. Bit 0 is connected to the 'Communicational data equivalent' table.</p>																									
	<table border="1"> <thead> <tr> <th colspan="2">RS485 bit rate</th> </tr> </thead> <tbody> <tr><td>0</td><td>2400bps</td></tr> <tr><td>1</td><td>4800bps</td></tr> <tr><td>2</td><td>9600bps</td></tr> <tr><td>3</td><td>19200bps</td></tr> <tr><td>4</td><td>38400bps</td></tr> <tr><td>5</td><td>57600bps</td></tr> <tr><td>6</td><td>115200bps</td></tr> </tbody> </table>					RS485 bit rate		0	2400bps	1	4800bps	2	9600bps	3	19200bps	4	38400bps	5	57600bps	6	115200bps					
	RS485 bit rate																									
	0	2400bps																								
1	4800bps																									
2	9600bps																									
3	19200bps																									
4	38400bps																									
5	57600bps																									
6	115200bps																									
<table border="1"> <thead> <tr> <th colspan="2">Communicational protocol</th> </tr> </thead> <tbody> <tr><td>0</td><td>8, N, 1 (Modbus protocol, RTU mode)</td></tr> <tr><td>1</td><td>8, N, 2 (Modbus protocol, RTU mode)</td></tr> <tr><td>2</td><td>8, E, 1 (Modbus protocol, RTU mode)</td></tr> <tr><td>3</td><td>8, O, 1 (Modbus protocol, RTU mode)</td></tr> <tr><td>4</td><td>7, N, 2 (Modbus protocol, ASCII mode)</td></tr> <tr><td>5</td><td>7, E, 1 (Modbus protocol, ASCII mode)</td></tr> <tr><td>6</td><td>7, O, 1 (Modbus protocol, ASCII mode)</td></tr> <tr><td>7</td><td>8, N, 2 (Modbus protocol, ASCII mode)</td></tr> <tr><td>8</td><td>8, E, 1 (Modbus protocol, ASCII mode)</td></tr> <tr><td>9</td><td>8, O, 1 (Modbus protocol, ASCII mode)</td></tr> </tbody> </table>					Communicational protocol		0	8, N, 1 (Modbus protocol, RTU mode)	1	8, N, 2 (Modbus protocol, RTU mode)	2	8, E, 1 (Modbus protocol, RTU mode)	3	8, O, 1 (Modbus protocol, RTU mode)	4	7, N, 2 (Modbus protocol, ASCII mode)	5	7, E, 1 (Modbus protocol, ASCII mode)	6	7, O, 1 (Modbus protocol, ASCII mode)	7	8, N, 2 (Modbus protocol, ASCII mode)	8	8, E, 1 (Modbus protocol, ASCII mode)	9	8, O, 1 (Modbus protocol, ASCII mode)
Communicational protocol																										
0	8, N, 1 (Modbus protocol, RTU mode)																									
1	8, N, 2 (Modbus protocol, RTU mode)																									
2	8, E, 1 (Modbus protocol, RTU mode)																									
3	8, O, 1 (Modbus protocol, RTU mode)																									
4	7, N, 2 (Modbus protocol, ASCII mode)																									
5	7, E, 1 (Modbus protocol, ASCII mode)																									
6	7, O, 1 (Modbus protocol, ASCII mode)																									
7	8, N, 2 (Modbus protocol, ASCII mode)																									
8	8, E, 1 (Modbus protocol, ASCII mode)																									
9	8, O, 1 (Modbus protocol, ASCII mode)																									
<table border="1"> <thead> <tr> <th colspan="2">Reserved</th> </tr> </thead> <tbody> <tr><td> </td><td> </td></tr> </tbody> </table>					Reserved																					
Reserved																										
<table border="1"> <thead> <tr> <th colspan="2">Communicational data equivalent</th> </tr> </thead> <tbody> <tr><td>0</td><td>Internal speed: 1rpm; internal torque: 1% rated torque.</td></tr> <tr><td>1</td><td>Internal speed: 0.1rpm; internal torque: 0.1% rated torque.</td></tr> </tbody> </table>					Communicational data equivalent		0	Internal speed: 1rpm; internal torque: 1% rated torque.	1	Internal speed: 0.1rpm; internal torque: 0.1% rated torque.																
Communicational data equivalent																										
0	Internal speed: 1rpm; internal torque: 1% rated torque.																									
1	Internal speed: 0.1rpm; internal torque: 0.1% rated torque.																									

---

## 10.3 Communication protocol

When using RS-485 for serial communications, each servo drive must set its own axis number (PA015). There are two MODBUS modes: ASCII (American Standard Code for Information Interchange) or RTU (Remote Terminal Unit).

### 10.3.1 Encoding definitions

◆ **ASCII mode:**

Every 8-bit data consists of two ASCII bytes.

<b>Byte symbol</b>	<b>'0'</b>	<b>'1'</b>	<b>'2'</b>	<b>'3'</b>	<b>'4'</b>	<b>'5'</b>	<b>'6'</b>	<b>'7'</b>
ASCII code	30H	31H	32H	33H	34H	35H	36H	37H
<b>Byte symbol</b>	<b>'8'</b>	<b>'9'</b>	<b>'A'</b>	<b>'B'</b>	<b>'C'</b>	<b>'D'</b>	<b>'E'</b>	<b>'F'</b>
ASCII code	38H	39H	41H	42H	43H	44H	45H	46H

◆ **RTU mode:**

Every 8-bits data consists of two 4-bits hexadecimal bytes.



---

### 10.3.2 Byte structure

◆ 10-bits byte box (used for 7-bits data)

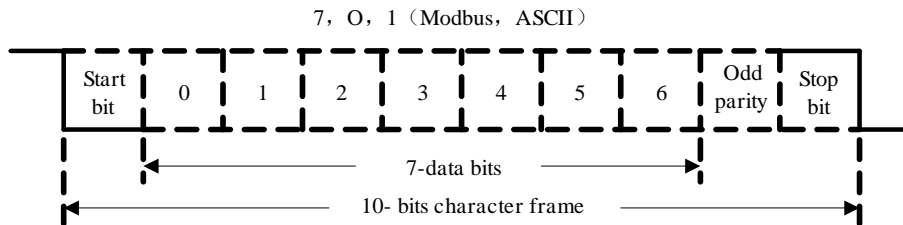
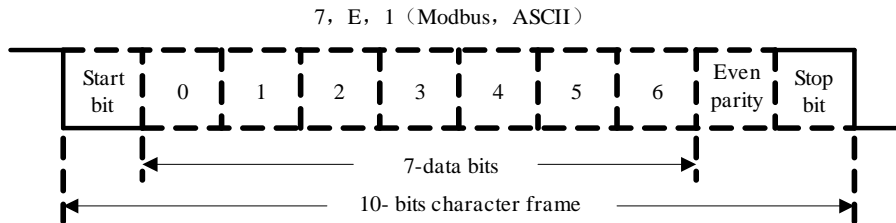
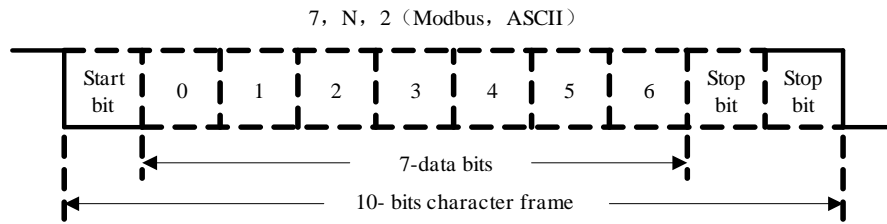

◆ 11-bits byte box (used for 8-bits data)

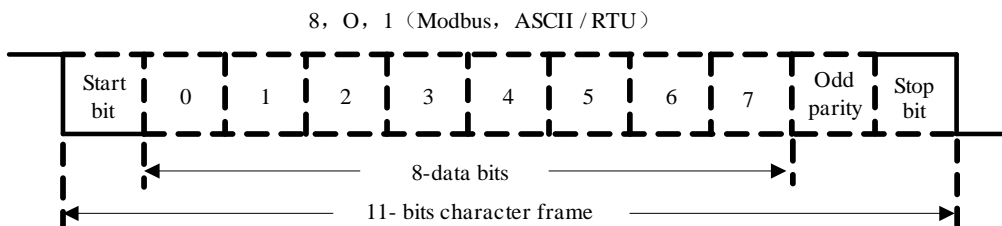
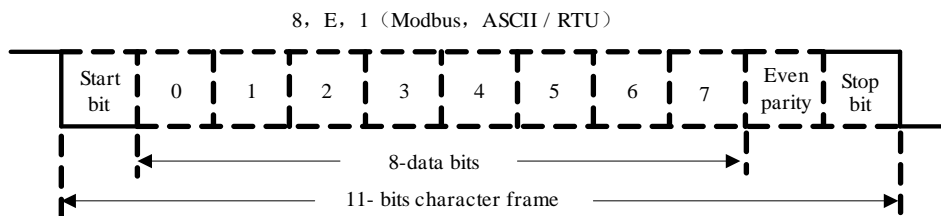
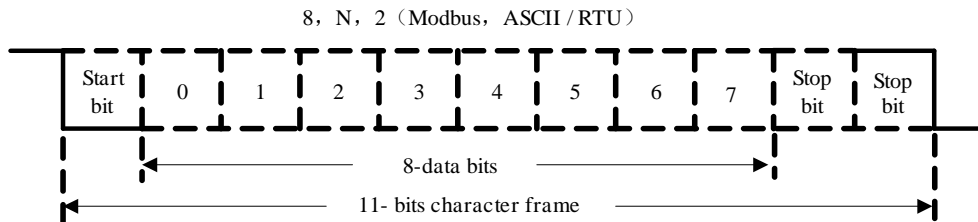

### 10.3.3 Communication data structure

◆ **ASCII mode:**

<b>STX</b>	Communication starting byte: ':' (3AH)
<b>ADR</b>	Communication address: 1-byte contains 2 ASCII codes
<b>CMD</b>	Command code: 1-byte contains 2 ASCII codes
<b>DATA (n-1)</b>	Data content (n≤12):
.....	Word number=n;
<b>DATA (0)</b>	Byte number=2n; ASCII code number=4n;
<b>LRC</b>	Command code: 1-byte contains 2 ASCII codes
<b>End 1</b>	End code 1: (0DH) (CR)
<b>End 0</b>	End code 0: (0AH) (LF)

**RTU mode**

<b>STX</b>	Static time exceeding 3.5 bytes
<b>ADR</b>	Communication address: 1-byte
<b>CMD</b>	Command code: 1-byte
<b>DATA (n-1)</b>	Data content (n≤12):
.....	Word number=n;
<b>DATA (0)</b>	Byte number=2n;
<b>CRC</b>	Command code: 1-byte
<b>End 1</b>	Static time exceeding 3.5 bytes

Detailed explanations are as below:

➤ **STX (Communication starting)**

ASCII mode: ':' byte (3AH).

RTU mode: Static time exceeding 3.5 bytes under current communication speed.

➤ **ADR (communication address)**

Valid communication address is between 1 and 127. For example: to communicate with servo drive of Axis 16 (hexadecimal: 10H):

ASCII mode: ADR='1', '0'=> '1'=31H, '0'=30H

RTU mode: ADR = 10H

➤ **CMD (command code) & DATA (data content)**

DATA format is determined by CMD. Common CMD listed below:

Command	Meaning	Remarks
03H	Read N words, N≤29	Standard command 03
06H	Write 1 word	Standard command 06
10H	Write N words, N≤29	Standard command 10

**1) CMD: 03H (Read N words,  $N \leq 29$ )**

For example, to continuously read 2 words from starting address 0200H of servo drive Axis 01H:

**ASCII mode:**

Command		Response	
STX	‘:’	STX	‘:’
ADR	‘0’	ADR	‘0’
	‘1’		‘1’
CMD	‘0’	CMD	‘0’
	‘3’		‘3’
Starting address (high to low)	‘0’	Data quantity (bytes)	‘0’
	‘2’		‘4’
	‘0’	Starting address 0200H (high to low)	‘0’
	‘0’		‘0’
Data quantity (WORD)	‘0’		‘B’
	‘0’		‘1’
	‘0’	Second address 0200H (high to low)	‘1’
	‘2’		‘F’
LRC Check (high to low)	‘F’		‘4’
	‘8’		‘0’
End 1	(0DH)	LRC Check (high to low)	‘E’
End 0	(0AH)		‘8’
		End 1	(0DH) (CR)
		End 0	(0AH) (LF)

**RTU mode:**

Command		Response	
ADR	01H	ADR	01H
CMD	03H	CMD	03H
Starting address (high to low)	02H	Data quantity (bytes)	04H
	00H	Starting address 0200H (high to low)	00H
Data byte number (high to low)	00H		
	02H	Second address 0200H (high to low)	1FH
CRC check low	C5H		40H
CRC check high	B3H	CRC check low	A3H
		CRC check high	D4H



2) **CMD: 06H (write one word)**

For example, write 100 (0064H) to starting address 0200H of servo drive Axis 01H:

**ASCII mode:**

<b>Command</b>		<b>Response</b>	
STX	‘.’	STX	‘.’
ADR	‘0’	ADR	‘0’
	‘1’		‘1’
CMD	‘0’	CMD	‘0’
	‘6’		‘6’
Starting address (high to low)	‘0’	Starting address 0200H (high to low)	‘0’
	‘2’		‘2’
	‘0’		‘0’
	‘0’		‘0’
Data content (high to low)	‘0’	Data content (high to low)	‘0’
	‘0’		‘0’
	‘6’		‘6’
	‘4’		‘4’
LRC Check (high to low)	‘9’	LRC Check (high to low)	‘9’
	‘3’		‘3’
End 1	(0DH) (CR)	End 1	(0DH) (CR)
End 0	(0AH) (LF)	End 0	(0AH) (LF)

**RTU mode:**

<b>Command</b>		<b>Response</b>	
ADR	01H	ADR	01H
CMD	06H	CMD	06H
Starting address (high to low)	02H	Starting address (high to low)	02H
	00H		00H
Data content (high to low)	00H	Data content (high to low)	00H
	64H		64H
CRC check low	89H	CRC check low	89H
CRC check high	99H	CRC check high	99H

**3) CMD: 10H (write N words,  $N \leq 29$ )**

For example, write 100 (0064H), 102 (0066H) to starting address 0200H of servo drive Axis 01H:

**ASCII mode:**

<b>Command</b>		<b>Response</b>	
<b>STX</b>	‘:’	<b>STX</b>	‘:’
<b>ADR</b>	‘0’	<b>ADR</b>	‘0’
	‘1’		‘1’
<b>CMD</b>	‘1’	<b>CMD</b>	‘1’
	‘0’		‘0’
<b>Starting address (high to low)</b>	‘0’	<b>Starting address (high to low)</b>	‘0’
	‘2’		‘2’
	‘0’		‘0’
	‘0’		‘0’
<b>Data word number (high place)</b>	‘0’	<b>Data word number (high to low)</b>	‘0’
	‘0’		‘0’
<b>Data word number (low place)</b>	‘0’		‘0’
	‘2’		‘2’
<b>Data byte number</b>	‘0’	<b>LRC Check (high to low)</b>	‘9’
	‘4’		‘3’
<b>Data 1 content (high to low)</b>	‘0’	<b>End 1</b>	(0DH) (CR)
	‘0’		<b>End 0</b>
	‘6’		
	‘4’		
<b>Data 2 content (high to low)</b>	‘0’		
	‘0’		
	‘6’		
	‘6’		
<b>LRC Check (high to low)</b>	‘1’		
	‘D’		
<b>End 1</b>	(0DH) (CR)		
<b>End 0</b>	(0AH) (LF)		

---

**RTU mode:**

**Command**

<b>ADR</b>	<b>01H</b>
<b>CMD</b>	<b>10H</b>
<b>Starting address (high to low)</b>	<b>02H</b>
	<b>00H</b>
<b>Data word number (high to low)</b>	<b>00H</b>
	<b>02H</b>
<b>Data byte number</b>	<b>04H</b>
<b>Data 1 content</b>	<b>00H</b>
	<b>64H</b>
<b>Data 2 content</b>	<b>00H</b>
	<b>66H</b>
<b>CRC check low</b>	<b>50H</b>
<b>CRC check high</b>	<b>11H</b>

**Response**

<b>ADR</b>	<b>01H</b>
<b>CMD</b>	<b>10H</b>
<b>Starting address (high to low)</b>	<b>02H</b>
	<b>00H</b>
<b>Data word number (high to low)</b>	<b>00H</b>
	<b>02H</b>
<b>CRC check low</b>	<b>40H</b>
<b>CRC check high</b>	<b>70H</b>

---

➤ **LRC (ASCII mode) & CRC (RTU mode) detected error value calculation**

**ASCII mode:**

ASCII mode uses LRC (Longitudinal Redundancy Check) to detect error value. LRC detected error value is the sum from ADR to last data content and use 256 as unit to remove excess part (for example: sum is 128H, then only use 28H), and then calculate supplement number of 2.

**RTU mode:**

RTU mode uses CRC (Cyclical Redundancy Check) detected error value.

Step 1: CRC register is a 16-bits register whose content is FFFFH;

Step 2: **Exclusive OR** compute first byte of command & low place byte of 16-bits CRC register and store the result back to CRC register.

Step 3: Check lowest place (LSB) of CRC register. If this place is 0, then move to the right by 1 place; If this place is 1, then CRC register value move to the right by 1 place and **Exclusive OR** compute with A001H.

Step 4: Go back to Step 3 until Step 3 has been executed 8 times; then to Step 5.

Step 5: Repeat Step 2 to Step 4 for next byte of the CMD until all bytes have been processed.

At this point, CRC register content is CRC detected error value.

Notes:

After calculated CRC detected error value, in command, shall first fill in CRC low place, then CRC high place.

**3) End1、End0 (communication end)**

**ASCII mode:**

(0DH) i.e. byte as 'r' (carriage return) & (0AH) i.e. byte as 'n' (new line), means communication end.

**RTU mode:**

Static time exceeding 3.5 bytes in current communication speed.



### 10.3.4 Communication troubleshooting

Common error causes are:

- When reading-writing parameters, data address is wrong;
- When writing parameters, data exceeds upper/lower limit of this parameter;
- Communication is interfered, data transmission error or verification error.

When above communication error occurs, the servo drive will continue running, meanwhile will send back an error frame.

Error frame format:

#### Upper controller data frame:

Start	Slave address	Command	Data address	Verification

#### Servo drive feedback error frame:

Start	Slave address	Response code	Error code	Verification

Error frame response code = command + 80H

Error code=00H: communication normal;

=01H: servo drive cannot recognize the request;

=02H: data address of the request does not exist in the servo drive;

=03H: data of the request is not allowed (exceeding upper/lower limit) ;

=04H: servo drive started to execute the request but failed;

For example: servo drive Axis number is 03H, write data 06H to parameter PA004. As both upper/lower limit of PA004 is 0, data cannot be written. Servo drive will send back an error frame; error code is 03H (exceeding upper/lower limit). Structure is as below.

#### Upper controller data frame:

Start	Slave address	Command	Data address	Verification
	03H	06H	0004H, 0006H	

#### Servo drive feedback error frame:

Start	Slave address	Response code	Error code	Verification
	03H	86H	03H	

**If slave address is 00H, this is broadcast data and the servo drive will send no feedback.**

## 10.4 Communication address

**Notes: W/R: writable/readable (R: readable only; W: writable only)**

Address	Meaning	Unit	Data type	W/R
0000~03E7H	Parameters in Chapter 12.3. Examples: PA005: 0005H PA101: 0065H PA307: 0133H		Unassigned hexadecimal Assigned hexadecimal Assigned 32-bit	W/R
0600~0628H: Monitoring display parameters.				
0600H	Motor speed (dP 00)	rpm	Assigned hexadecimal	R
0601H	Motor feedback pulse number (encoder unit, lower 4 digits) (dP 01)	pulse	Assigned hexadecimal	R
0602H	Motor feedback pulse number (encoder unit, higher 5 digits) (dP 02)	pulse	Assigned hexadecimal	R
0603H	Input pulse number before electronic gear (user unit, lower 4 digits) (dP 03)	pulse	Assigned hexadecimal	R
0604H	Input pulse number before electronic gear (user unit, higher 5 digits) (dP 04)	pulse	Assigned hexadecimal	R
0605H	Deviation pulse number (encoder unit, lower 4 digits) (dP 05)	pulse	Assigned hexadecimal	R
0606H	Deviation pulse number (encoder unit, higher 5 digits) (dP 06)	pulse	Assigned hexadecimal	R
0607H	Speed instruction (analog voltage instruction) (dP 07)	0.01V	Unassigned hexadecimal	R
0608H	Internal speed instruction (dP 08)	rpm	Assigned hexadecimal	R
0609H	Torque instruction (analog voltage instruction) (dP 09)	0.01V	Unassigned hexadecimal	R
060AH	Internal torque instruction (value in relation to the rated torque) (dP 10)	%	Assigned hexadecimal	R
060BH	Torque feedback (value in relation to the rated torque) (dP 11)	%	Assigned hexadecimal	R
060CH	Input signal monitoring (dP 12)		Unassigned hexadecimal	R
060DH	Output signal monitoring (dP 13)		Unassigned hexadecimal	R
060EH	Instruction pulse frequency (dP 14)	0.1Khz	Assigned hexadecimal	R
060FH	DC bus voltage (dP 15)	V	Unassigned hexadecimal	R
0610H	Total operation time (dP 16)	H	Unassigned hexadecimal	R
0611H	Rotation angle (dP 17)		Unassigned hexadecimal	R
0612H	Exact position of absolute encoder (single-turn or multi-turn) (dP 18)	2 pulses	Unassigned hexadecimal	R
0613H	Number of encoder turns (only effective for multi-turn absolute encoders) (dP 19)	turn	Unassigned hexadecimal	R

0614H	Cumulative load factor (take the rated cumulative load as 100%) (dP 20)	%	Unassigned hexadecimal	R
0617H	Load inertial ratio (dP 23)	%	Unassigned hexadecimal	R
0618H	Effective gain monitoring (dP 24)		Unassigned hexadecimal	R
0630H	Current alarm code		Unassigned hexadecimal	R
0631H	Current warning code		Unassigned hexadecimal	R
0780H	Absolute encoder multi-turn data	turn	Unassigned hexadecimal	R
0781H	Absolute encoder single turn data high place	pulse	Unassigned 32-bit	R
0782H	Absolute encoder single turn data low place	pulse		R
0783H	Motor feedback position low place	pulse	Assigned 32-bit	R
0784H	Motor feedback position high place	pulse		R
0785H	Motor reference position low place	pulse	Assigned 32-bit	R
0786H	Motor reference position high place	pulse		R

**Notes:**

All data is displayed in hexadecimal (16-bit or 32-bit). 32-bit data consists of two 16-bit data. For example, 0781H data is 0001H and 0782H data is 013AH; then absolute encoder single turn data is 0001013AH.

# Chapter 11 Product specifications

## 11.1 Servo drive specifications

### 11.1.1 Basic specifications

Input voltage	220VAC		Single/Three Phase 220VAC -15%~+10%, 50/60Hz	
	380VAC		Three Phase 380VAC -15%~+15%, 50/60Hz	
Control mechanism			<ul style="list-style-type: none"> <li>▪ Single/Three phase full wave rectification</li> <li>▪ IGBT PWM control, sine-wave current control</li> </ul>	
Feedback devices			<ul style="list-style-type: none"> <li>▪ 5000-LINE LINE-SAVING (GAIN)</li> <li>▪ 17-BIT SERIAL (ABSOLUTE)</li> <li>▪ 20-BIT SERIAL (GAIN)</li> </ul>	
Use conditions	Ambient temperature		<ul style="list-style-type: none"> <li>▪ Use temperature: 0~+45°C</li> <li>▪ Storage temperature: -20~55°C</li> </ul>	
	Humidity		Below 90%RH (no freezing or condensing)	
	Vibration		4.9 m/s <sup>2</sup> ~19.6 m/s <sup>2</sup>	
	Protection class/cleanness		Protection class: IP10; Cleanness: 2. But should be: <ul style="list-style-type: none"> <li>▪ ·With no corrosive or combustible gas</li> <li>▪ ·With no water, oil or drug splashing</li> <li>▪ ·With little dust, ash, salt or metallic powder</li> </ul>	
	Altitude		Below 1000m	
Performance	Speed control precision		1:5000	
	Speed fluctuation rate	Load fluctuation	0~100% load: below ±0.01% (at rated speed)	
		Voltage fluctuation	Rated voltage ±10%: 0.001% (at rated speed)	
		Temperature fluctuation	25 ±25°C: below ±0.1% (at rated speed)	
	Torque control precision		±3% (repeatable)	
	Soft start time		0~5s (acceleration or deceleration)	
Input/output signals	Encoder pulse output (A phase, B phase, Z phase)		<ul style="list-style-type: none"> <li>▪ 5000 line-saving encoder: 16~5000;</li> <li>▪ 17-bit serial encoder: 16~16384;</li> <li>▪ 20-bit serial encoder: 16~1,048,576.</li> </ul>	
	Sequential input signals	Pin number	8	
		Functions	S-ON, C-MODE, POT, NOT, etc.	
	Sequential output signals	Pin number	4	

		Functions	ALM, COIN, CZ, BK-OFF, S-RDY, etc.
Communication functions	RS485	1: N	With relay, maximum N=31
		Address	By parameter setting
		Devices	PC, upper controller
Display/keypad		7 LED X 5 bit, 4 buttons	
Dynamic brake (DB) (optional)		At Servo OFF, forward/backward rotation inhibition, power OFF, or stop due to failure.	
Regenerative functions		Internal or external	
Over-travel (OT) protections		POT, NOT. DB, deceleration to stop, coast to stop.	
Protection functions		Over-current, over-voltage, under-voltage, over-load, regenerative fault, etc.	

### 11.1.2 Position/speed/torque control specifications

Position control	Feedforward compensation		0~100% (Unit: 1%)				
	Position completion width		0~65535 Encoder unit				
	Input signals	Pulse form	PULS+SIGN, CW+CCW, A+B				
		Pulse status	Support line-driver, open collector				
		Maximum input pulse frequency		PULS+SIGN	CW+CCW	A+B	
			Long line-driver	4Mbps	4 Mbps	1 Mbps	
			Line-driver	500Kbps	500Kbps	125Kbps	
	Open-collector		200Kbps	200Kbps	200Kbps		
Clearance		Clear deviation pulses					
Internal position	Position selection	External input signals					
Speed control	Soft start time		0~5s				
	Input signals	Instruction voltage	±10 V				
		Input resistance	Approximately 9kΩ				
	Internal speed	Speed selection	External input signals				
Torque control	Input signals	Instruction voltage	±10 V				
		Input resistance	Approximately 9kΩ				

### 11.1.3 Servo drive dimensions

A type case:

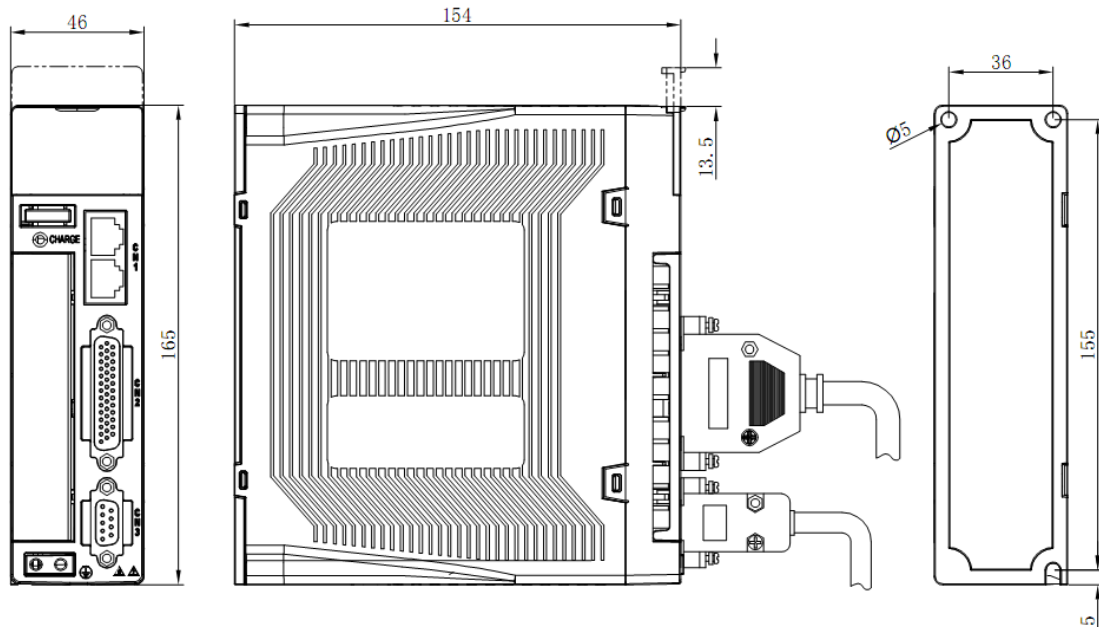

B type case:

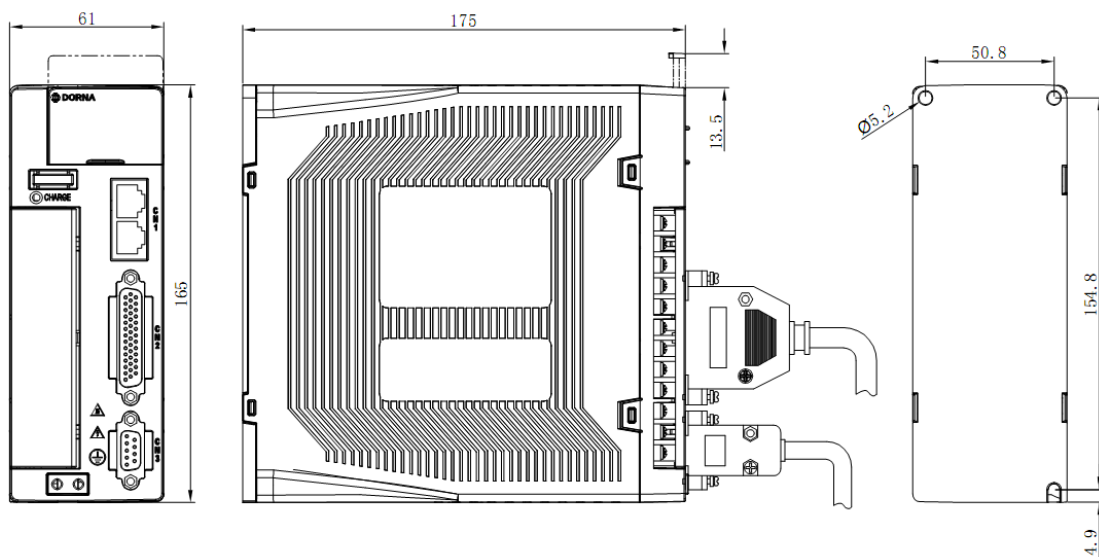

## C type case:

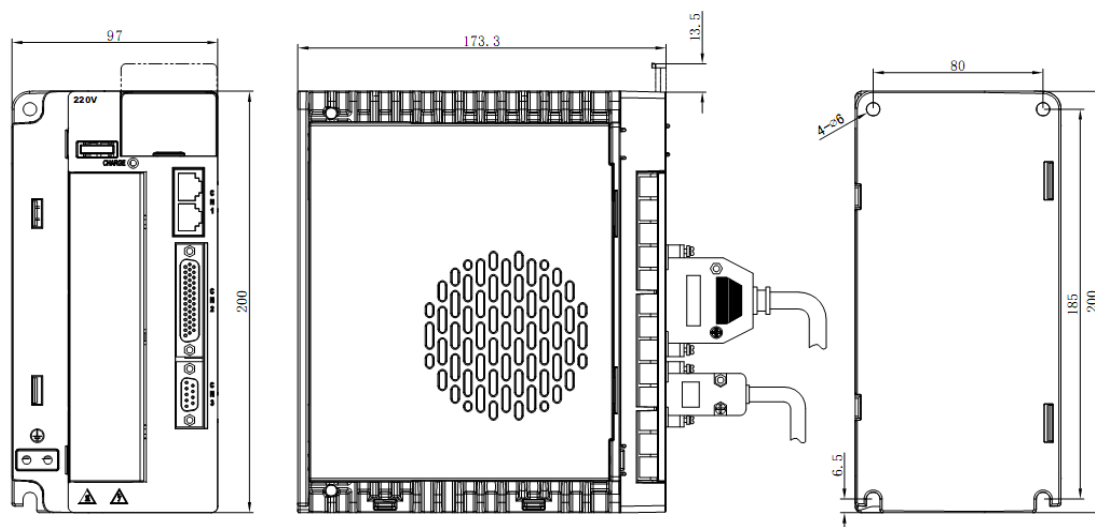

### Notes:

- Unit is mm.
- Dimensions are subject to changes without prior notice.

## 11.2 Servo motor specifications & dimensions

### General specifications

Working system: S1 continuous

Heat resistance class: B

Vibration: 5G

Insulation voltage class: AC1500V, 1 minute

Insulation resistance: DC500V, above 10M $\Omega$

Installation mode: Flange

Working temperature: 0~40°C (no freezing)

Operating humidity: 20%~80% (no dewing)

Altitude: Below 1000m

Protections: Full-enclosed IP65 (except the shaft-through part)

## 60/80 Series

Servo Motor series	60 series		80 Series	
Servo Motor model	60DNMA2-0D20D	60DNMA2-0D40D	80DNMA1-0D75D	80DNMA1-0001D
Input voltage	220VAC			
Inertia	Medium	Medium	Medium	Medium
Rated power (W)	200	400	750	1000
Rated torque (N*m)	0.64	1.27	2.39	3.18
Rated current (A)	1.4	2.5	4.1	5.5
Maximum current (A)	4.2	7.5	12.5	15.1
Rated speed (rpm)	3000	3000	3000	3000
Maximum speed (rpm)	5000	5000	5000	5000
Torque constant (N*m/Amp)	0.45	0.508	0.58	0.43
Back EMF constant (V/Krpm)	29	33	40	40
Rotary inertia (with brake) (10-4Kg*m <sup>2</sup> )	0.14 (0.16)	0.67 (0.68)	0.88 (0.92)	1.12 (1.15)
Resistance (line-line) (Ω)	8.4	4.28	1.5	1.21
Inductance (line-line) (mH)	26.5	15.4	7.9	6.2
Mass (with brake) (kg)	1.03 (1.53)	1.59 (2.05)	2.66 (3.76)	3.12 (4.22)
LL (with brake) (mm)	105(140)	140(175)	129.7(168.9)	144.7(183.9)
LR (mm)	30	30	35	35
LE (mm)	3	3	3	3
LG (mm)	8	8	8	8
S (mm)	14	14	19	19
LJ1 (mm)	0	0	0	0
LJ (mm)	11	11	15.5	15.5
J (mm)	20	20	25	25
LF1 (mm)	5	5	6	6
LF2 (mm)	5	5	6	6
LM (mm)	M4 deep 15	M4 deep 15	M5 deep 20	M5 deep 20
LA (mm)	70	70	90	90
LB (mm)	50	50	70	70
LC (mm)	60	60	80	80
LZ (mm)	5.5	5.5	6.5	6.5

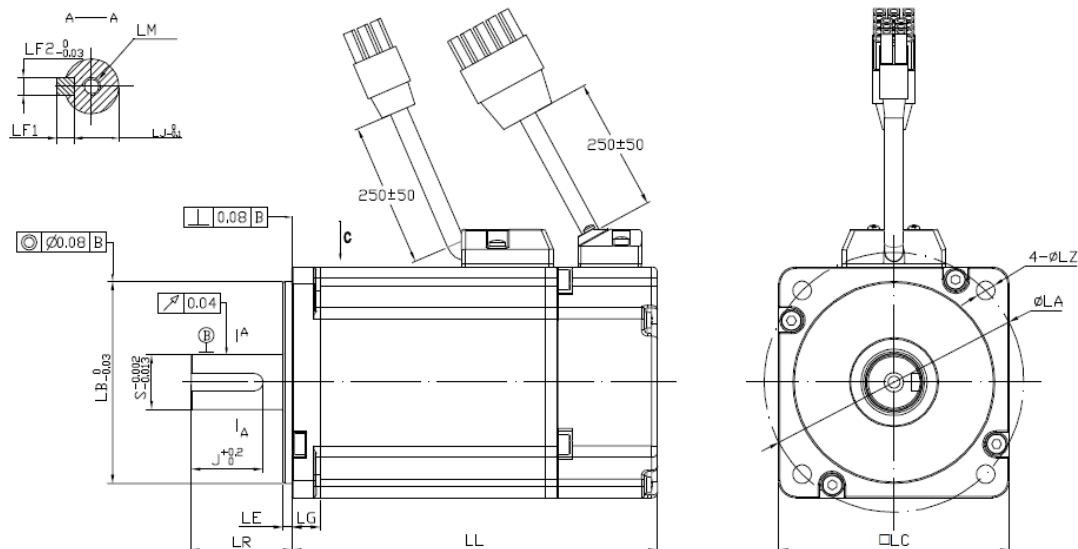



### 130 Series (220V class)

Servo Motor series	130 Series			
Servo Motor model	130DNMA2-0001C	130DNMA2-01D5C	130DNMA2-0002C	130DNMA2-0003C
Input voltage	220VAC			
Rated power (KW)	1	1.5	2.2	3
Rated torque (N*m)	4.77	7.16	9.55	14.33
Maximum torque (N*m)	5	8.4	10.3	13.5
Rated current (A)	15	25.2	30.1	40.5
Maximum current (A)	2000	2000	2000	2000
Rated speed (rpm)	3000	3000	3000	3000
Maximum speed (rpm)	0.95N.m/Arms	0.85N.m/Arms	0.93N.m/Arms	1.07N.m/Arms
Torque constant (N*m/Amp)	66V/Krpm	59.8V/Krpm	72.6V/Krpm	76V/Krpm
Back EMF constant (V/Krpm)	7.1 (7.5)	10.6 (11.1)	13.8 (14.3)	20.4 (20.9)
Rotary inertia (w/brake) (10-4Kg*m2)	1.08	0.543	0.52	0.32
Resistance (line-line) ( $\Omega$ )	12.8	6.3	6.8	4.7
Inductance (line-line) (mH)	6.5 (8.8)	8 (10.5)	9.6 (11.9)	12.6 (14.9)
Mass (with brake) (kg)	154 (198)	173 (217)	192 (236)	230 (274)
LL (with brake) (mm)	58	58	58	58
LR (mm)	6	6	6	6
LE (mm)	12	12	12	12
LG (mm)	22	22	22	22
S (mm)	0	0	0	0
LJ1 (mm)	18	18	18	18
LJ (mm)	36	36	36	36
J (mm)	7	7	7	7
LF1 (mm)	8	8	8	8
LF2 (mm)	M6 deep 15	M6 deep 15	M6 deep 15	M6 deep 15
LM (mm)	145	145	145	145
LA (mm)	110	110	110	110
LB (mm)	130	130	130	130
LC (mm)	9.5	9.5	9.5	9.5
LZ (mm)	4.77	7.16	9.55	14.33

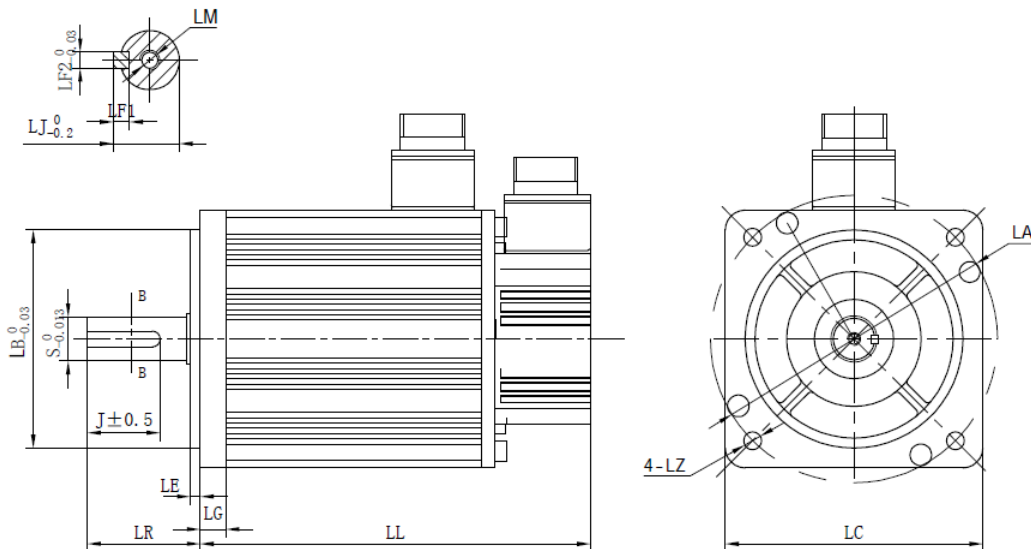

# Chapter 12 Appendix

## 12.1 List of monitoring display functions

No.	Function	Unit
dP 00	<b>Motor speed</b> Display the motor operating speed	[rpm]
dP 01	<b>Motor feedback pulse number (encoder unit, lower 4 digits)</b> Display the lower 4 digits of the sum of motor encoder feedback pulse.	[1 encoder pulse]
dP 02	<b>Motor feedback pulse number (encoder unit, higher 5 digits)</b> Display the higher 5 digits of the sum of motor encoder feedback pulse.	[10 <sup>4</sup> encoder pulses]
dP 03	<b>Input pulse number before electronic gear (user unit, lower 4 digits)</b> Lower 4 digits of the sum of input pulse number in position control mode.	[1 input pulse]
dP 04	<b>Input pulse number before electronic gear (user unit, higher 5 digits)</b> Higher 5 digits of the sum of input pulse number in position control mode.	[[10 <sup>4</sup> input pulses]
dP 05	<b>Deviation pulse number (encoder unit, lower 4 digits)</b> Lower 4 digits of the sum of deviation pulse number in position control mode.	[1 encoder pulse]
dP 06	<b>Deviation pulse number (encoder unit, higher 5 digits)</b> Higher 5 digits of the sum of deviation pulse number in position control mode.	[10 <sup>4</sup> encoder pulses]
dP 07	<b>Speed instruction (analog voltage instruction)</b> Voltage value of analog input in speed control mode, after correction of null shift. When the voltage exceeds ±10V, it cannot be displayed correctly.	[0.1V]
dP 08	<b>Internal speed instruction</b> Internal speed instruction under speed control and position control.	[r/min]
dP 09	<b>Torque instruction (analog voltage instruction)</b> Voltage value of analog input in torque control mode, after correction of null shift. When the voltage exceeds ±10V, it cannot be displayed correctly.	[0.1V]
dP 10	<b>Internal torque instruction (value in relation to the rated torque)</b> Internal torque instruction in torque / speed / position control modes.	[%]
dP 11	<b>Torque feedback (value in relation to the rated torque)</b> Torque feedback value in torque / speed / position control modes.	[%]

dP 12	<b>Input signal monitoring</b> Input signal status of CN2 connector	-
dP 13	<b>Output signal monitoring</b> Output signal status of CN2 connector	-
dP 14	<b>Instruction pulse frequency</b> Instruction pulse frequency of the upper controller in position control.	[0.1Khz]
dP 15	<b>DC bus voltage</b> DC bus voltage after rectification	[V]
dP 16	<b>Total operation time of the servo drive</b> If AF05 operation is implemented, the value will be reset.	[Hours]
dP 17	<b>Rotation angle</b> Display the electric rotational angle of the motor.	[deg]
dP 18	<b>Exact position of absolute encoder (single-turn or multi-turn)</b> This displays the absolute position data of the encoder in one turn.	[2 Encoder pulse]
dP 19	<b>Number of encoder turns (only for multi-turn absolute encoders)</b> This displays the number of turns of multi-turn absolute encoder.	[1 turn]
dP 20	<b>Cumulative load factor (take rated cumulative load as 100%)</b> Alarm grade during motor overload protection.	[%]
dP 21	<b>Regeneration load factor (take rated regeneration load as 100%)</b> Alarm grade during regeneration overload protection	[%]
dP 22	<b>DB load factor (take rated DB load as 100%)</b> Alarm grade during DB braking protection	[%]
dP 23	<b>Load inertial ratio</b> Display the ratio between load inertia and motor inertia.	[%]
dP 24	<b>Effective gain monitoring</b> 1: the first group of gains is effective 2: the second group of gains is effective	-
dP 30	<b>Subsidiary software version (refer to AF 10 for main software version)</b>	-
dP 34	<b>External linear encoder feedback pulse counts low place</b>	[1 encoder pulse]
dP 35	<b>External linear encoder feedback pulse counts high place</b>	[10 <sup>4</sup> encoder pulses]
dP 38	<b>Hybrid deviation low place</b>	[1 encoder pulse]
dP 39	<b>Hybrid deviation high place</b>	[10 <sup>4</sup> encoder pulses]
dP 40	<b>Voltage class (refer to PA000.3 for voltage class setting)</b>	-
dP 46	<b>IGBT temperature</b>	°C

---

## 12.2 List of auxiliary function parameters

No.	Function	Reference
AF 00	Display of alarm logging	6.2
AF 01	Position assignment (only active in position control mode)	6.3
AF 02	JOG run	6.4
AF 03	Panel lock	6.5
AF 04	Clearance of alarm logging	6.6
AF 05	Parameter initialization	6.7
AF 06	Analog instruction (speed & torque) automatic offset adjustment	6.8
AF 07	Speed instruction manual offset adjustment	6.9
AF 08	Torque instruction manual offset adjustment	6.10
AF 09	Overview of relevant motor parameters	6.11
AF 10	Display of main software version of servo drive	6.12
AF 11	Setting up absolute encoders	6.13
AF 12	Clearance of error logging for absolute encoders	6.13
AF 15	Manual detection of load inertia	6.14

## 12.3 List of parameters

### Legends:

- P: Parameter number.
- Descriptions: Parameter detailed descriptions.
- Range: Parameter setting range.
- Unit: Parameter unit.
- Defau: Parameter factory default setting value.
- Effective: Parameter effective time.
  - Immed: Parameter to be effective immediately.
  - Restart: Parameter to be effective after restart the servo drive.
- R: Remarks

P	Descriptions	Range	Unit	Defau	Effective	R
PA000	<b>Basic function selection 1</b>	h.0000~01D1		h.0000	Restart	
	h. <input type="checkbox"/> <sup>3</sup> <input type="checkbox"/> <sup>2</sup> <input type="checkbox"/> <sup>1</sup> <input type="checkbox"/> <sup>0</sup>					
		<b>Direction selection</b>				
		0 Positive mode				
		1 Negative mode				
		<b>Control mode selection</b>				
		0 Position control (pulse train)				
		1 Speed control (analog instruction)				
		2 Torque control (analog instruction)				
		3 Internal speed control				
	4 Internal speed control ←→ Position control					
	5 Internal speed control ←→ Speed control					
	6 Internal speed control ←→ Torque control					
	7 Position control ←→ Speed control					
	8 Position control ←→ Torque control					
	9 Torque control ←→ Speed control					
	A Internal position control					
	B Internal position control ←→ Position control					
	C Reserved					
	D Fully closed loop control					
	<b>Reserved</b>					
	<b>Input voltage of servo drive</b>					
	0 220V class					
	1 380V class					
	<b>Notes:</b>					
	▪ 220V class: PA000.3=0;					
	▪ 380V class: PA000.3=1;					
	▪ Execute AF 05 (parameter initialization) after modifying PA000.3.					

P	Descriptions	Range	Unit	Defau	Effective	R
PA001	<b>Basic function selection 2</b>	d.0000~0264		d.0000	Restart	

PA001

d.  <sup>3</sup>  <sup>2</sup>  <sup>1</sup>  <sup>0</sup>

#### Servo stop patterns at servo OFF or alarms

0	DB (dynamic brake) to stop
1	DB (dynamic brake) to stop, then release DB
2	Coast to stop, DB not used
3	Decelerate at rate of PA522, & stay in DB state when speed is lower than PA523
4	Decelerate at rate of PA522, & coast to stop when speed is lower than PA523

#### Servo stop patterns at OT (Overtravel)

0	DB or coast to stop, same as PA001.0 (1~2)
1	Stop by torque set in PA406, then enter lock state
2	Stop by torque set in PA406, then coast to stop
3	Stop by torque set in PA406, after fully stopped, then enter DB state
4	Stop by torque set in PA406, decelerate at rate of PA522, then enter lock state
5	Stop by torque set in PA406, decelerate at rate of PA522, then coast to stop
6	Stop by torque set in PA406, decelerate at rate of PA522, then enter DB state

#### AC/DC input power selection

0	AC input: Single phase 220VAC among L1, L2, L3
1	AC input: Three phase 220VAC among L1, L2, L3
2	DC input: 310VDC between P+, (-)

#### Enabling selection

0	External enable from I/O or communication
1	Internal enable

P	Descriptions	Range	Unit	Defau	Effective	R																												
PA002	<b>Basic function selection 3</b>	d.0000~8112		d.0000	Restart																													
	<p>b. <input type="checkbox"/> <sup>3</sup> <input type="checkbox"/> <sup>2</sup> <input type="checkbox"/> <sup>1</sup> <input type="checkbox"/> <sup>0</sup></p> <table border="1"> <thead> <tr> <th colspan="2">Torque limit in position control &amp; speed control modes selection</th> </tr> </thead> <tbody> <tr> <td>0</td> <td>Invalid</td> </tr> <tr> <td>1</td> <td>Use T-REF as external analog torque limit input</td> </tr> <tr> <td>2</td> <td>Use PCL, NCL as external analog torque limit input</td> </tr> </tbody> </table> <table border="1"> <thead> <tr> <th colspan="2">Speed limit in torque control mode selection</th> </tr> </thead> <tbody> <tr> <td>0</td> <td>Use PA407 as speed limit (internal speed limit)</td> </tr> <tr> <td>1</td> <td>Use V-REF &amp; PA301 setting as speed limit (external speed limit)</td> </tr> </tbody> </table> <table border="1"> <thead> <tr> <th colspan="2">Use of absolute encoders</th> </tr> </thead> <tbody> <tr> <td>0</td> <td>Use absolute encoders as incremental encoders</td> </tr> <tr> <td>1</td> <td>Use absolute encoders as absolute encoders</td> </tr> </tbody> </table> <table border="1"> <thead> <tr> <th colspan="2">Encoder type selection</th> </tr> </thead> <tbody> <tr> <td>0</td> <td>Absolute encoder (single-turn 17-bit, multi-turn 16-bit)</td> </tr> <tr> <td>1</td> <td>Single-turn absolute encoder (single-turn 17-bit, resolution 131072)</td> </tr> <tr> <td>2</td> <td>Line-saving encoder (5000ppr, resolution 20000ppr)</td> </tr> </tbody> </table>	Torque limit in position control & speed control modes selection		0	Invalid	1	Use T-REF as external analog torque limit input	2	Use PCL, NCL as external analog torque limit input	Speed limit in torque control mode selection		0	Use PA407 as speed limit (internal speed limit)	1	Use V-REF & PA301 setting as speed limit (external speed limit)	Use of absolute encoders		0	Use absolute encoders as incremental encoders	1	Use absolute encoders as absolute encoders	Encoder type selection		0	Absolute encoder (single-turn 17-bit, multi-turn 16-bit)	1	Single-turn absolute encoder (single-turn 17-bit, resolution 131072)	2	Line-saving encoder (5000ppr, resolution 20000ppr)					
Torque limit in position control & speed control modes selection																																		
0	Invalid																																	
1	Use T-REF as external analog torque limit input																																	
2	Use PCL, NCL as external analog torque limit input																																	
Speed limit in torque control mode selection																																		
0	Use PA407 as speed limit (internal speed limit)																																	
1	Use V-REF & PA301 setting as speed limit (external speed limit)																																	
Use of absolute encoders																																		
0	Use absolute encoders as incremental encoders																																	
1	Use absolute encoders as absolute encoders																																	
Encoder type selection																																		
0	Absolute encoder (single-turn 17-bit, multi-turn 16-bit)																																	
1	Single-turn absolute encoder (single-turn 17-bit, resolution 131072)																																	
2	Line-saving encoder (5000ppr, resolution 20000ppr)																																	
PA003	<b>Basic function selection 4</b>	b.0000~0111		b.0011	Restart																													
	<p>b. <input type="checkbox"/> <sup>3</sup> <input type="checkbox"/> <sup>2</sup> <input type="checkbox"/> <sup>1</sup> <input type="checkbox"/> <sup>0</sup></p> <table border="1"> <thead> <tr> <th colspan="2">Forward rotation prohibited (POT) (OT)</th> </tr> </thead> <tbody> <tr> <td>0</td> <td>Valid</td> </tr> <tr> <td>1</td> <td>Invalid</td> </tr> </tbody> </table> <table border="1"> <thead> <tr> <th colspan="2">Reverse rotation prohibited (NOT) (OT)</th> </tr> </thead> <tbody> <tr> <td>0</td> <td>Valid</td> </tr> <tr> <td>1</td> <td>Invalid</td> </tr> </tbody> </table> <table border="1"> <thead> <tr> <th colspan="2">OT alarm selection</th> </tr> </thead> <tbody> <tr> <td>0</td> <td>No alarm at POT/NOT input</td> </tr> <tr> <td>1</td> <td>E.35 alarm at POT/NOT input</td> </tr> </tbody> </table> <table border="1"> <thead> <tr> <th colspan="2">Z pulse signal negation</th> </tr> </thead> <tbody> <tr> <td>0</td> <td>Not negated</td> </tr> <tr> <td>1</td> <td>Negated</td> </tr> </tbody> </table>	Forward rotation prohibited (POT) (OT)		0	Valid	1	Invalid	Reverse rotation prohibited (NOT) (OT)		0	Valid	1	Invalid	OT alarm selection		0	No alarm at POT/NOT input	1	E.35 alarm at POT/NOT input	Z pulse signal negation		0	Not negated	1	Negated									
Forward rotation prohibited (POT) (OT)																																		
0	Valid																																	
1	Invalid																																	
Reverse rotation prohibited (NOT) (OT)																																		
0	Valid																																	
1	Invalid																																	
OT alarm selection																																		
0	No alarm at POT/NOT input																																	
1	E.35 alarm at POT/NOT input																																	
Z pulse signal negation																																		
0	Not negated																																	
1	Negated																																	
PA004	<b>Reserved</b>	b.0000~0011		b.0001	Restart																													

P	Descriptions	Range	Unit	Defau	Effective	R
PA005	<b>Basic function selection 6</b>	d.0000~0044		d.1022	Immed	

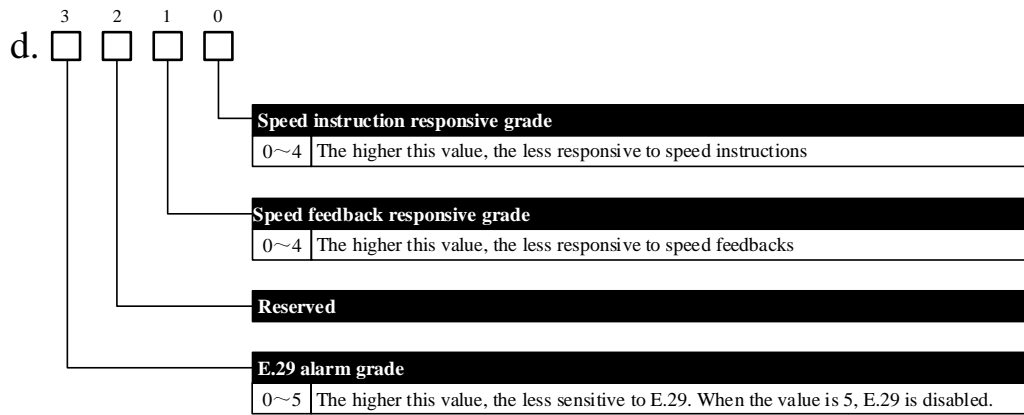

PA007	<b>Basic function selection 8</b>	d.0000~1211		b.0000	Restart	
-------	-----------------------------------	-------------	--	--------	---------	--

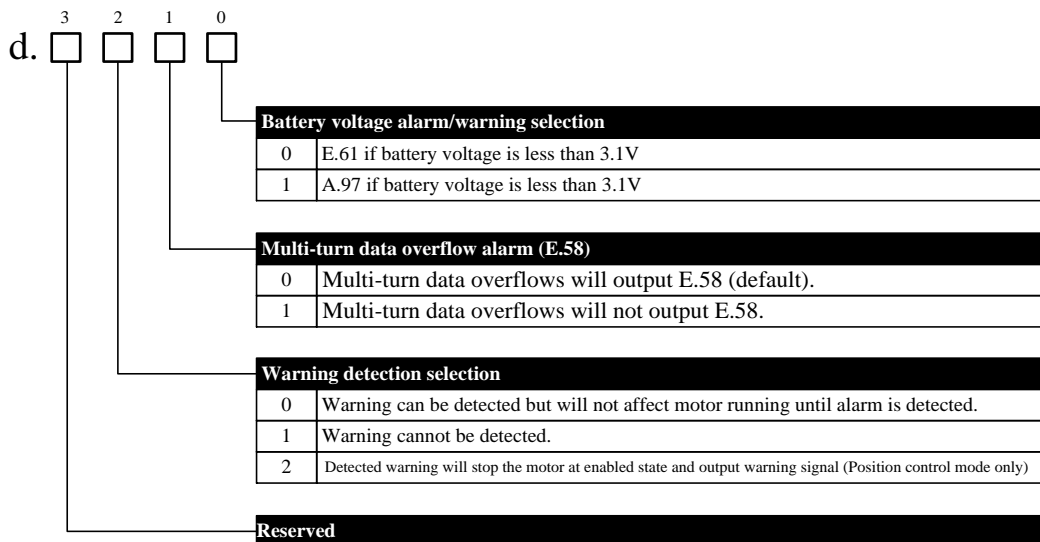



P	Descriptions	Range	Unit	Defau	Effective	R																
PA009	<b>Basic function selection 10</b>	b.0000~0011		b.0000	Restart																	
	<p>b. <input type="checkbox"/> <sup>3</sup> <input type="checkbox"/> <sup>2</sup> <input type="checkbox"/> <sup>1</sup> <input type="checkbox"/> <sup>0</sup></p> <p><b>Regenerative circuit detection</b></p> <table border="1"> <tr><td>0</td><td>Detect. E.17 will output if there are problems.</td></tr> <tr><td>1</td><td>Not detect.</td></tr> </table> <p><b>Regenerative resistor selection</b></p> <table border="1"> <tr><td>0</td><td>Use internal resistor</td></tr> <tr><td>1</td><td>Use external resistor. Make sure to set PA537, PA538 correctly.</td></tr> </table> <p><b>IGBT temperature detection</b></p> <table border="1"> <tr><td>0</td><td>Not detect.</td></tr> <tr><td>1</td><td>Detect (only valid for 380V class models).</td></tr> </table> <p><b>Motor temperature detection</b></p> <table border="1"> <tr><td>0</td><td>Not detect.</td></tr> <tr><td>1</td><td>Detect (only applicable to certain models).</td></tr> </table>	0	Detect. E.17 will output if there are problems.	1	Not detect.	0	Use internal resistor	1	Use external resistor. Make sure to set PA537, PA538 correctly.	0	Not detect.	1	Detect (only valid for 380V class models).	0	Not detect.	1	Detect (only applicable to certain models).					
0	Detect. E.17 will output if there are problems.																					
1	Not detect.																					
0	Use internal resistor																					
1	Use external resistor. Make sure to set PA537, PA538 correctly.																					
0	Not detect.																					
1	Detect (only valid for 380V class models).																					
0	Not detect.																					
1	Detect (only applicable to certain models).																					
PA010	<b>Basic function selection 11</b>	d.0000~9953		d.0021	Immed																	
	<p>d. <input type="checkbox"/> <sup>3</sup> <input type="checkbox"/> <sup>2</sup> <input type="checkbox"/> <sup>1</sup> <input type="checkbox"/> <sup>0</sup></p> <p><b>Speed detection filter grade</b></p> <table border="1"> <tr><td>0~3</td><td>The larger this value, the longer detection time. Sometimes this parameter can increase gain and reduce vibrations.</td></tr> </table> <p><b>Analog instruction input delay</b></p> <table border="1"> <tr><td>0~5</td><td>The larger this value, the more delay of analog instruction sampling, but the more accurate the measurement is.</td></tr> </table> <p><b>Regenerative resistor load ratio selection</b></p> <table border="1"> <tr><td>0~9</td><td>The larger this value, the longer overload time.</td></tr> </table> <p><b>Motor overload grade</b></p> <table border="1"> <tr><td>0~9</td><td>The larger this value, the longer overload time.</td></tr> </table>	0~3	The larger this value, the longer detection time. Sometimes this parameter can increase gain and reduce vibrations.	0~5	The larger this value, the more delay of analog instruction sampling, but the more accurate the measurement is.	0~9	The larger this value, the longer overload time.	0~9	The larger this value, the longer overload time.													
0~3	The larger this value, the longer detection time. Sometimes this parameter can increase gain and reduce vibrations.																					
0~5	The larger this value, the more delay of analog instruction sampling, but the more accurate the measurement is.																					
0~9	The larger this value, the longer overload time.																					
0~9	The larger this value, the longer overload time.																					
PA011	<b>Reserved</b>	0~5		2	Restart																	
PA012	<b>Motor model selection</b> <b>Please refer to chapter 1.3 for correct matching parameter.</b> After modifying this parameter, AF05 must be executed.	0~135		12	Restart																	
PA013	<b>Reserved</b>																					
P	<b>Status code display</b>	0~50		50	Restart																	

P	Descriptions	Range	Unit	Defau	Effective	R																																												
	<b>Please refer to chapter 4.3 &amp; 5.4 for details.</b>																																																	
PA015	RS485 communication address	1~31		1	Immed																																													
PA016	RS485 communication function selection	d.0000~1096		d.0095	Immed																																													
	<p>d. <input type="checkbox"/> <sup>3</sup> <input type="checkbox"/> <sup>2</sup> <input type="checkbox"/> <sup>1</sup> <input type="checkbox"/> <sup>0</sup></p> <table border="1"> <thead> <tr> <th colspan="2">RS485 bit rate</th> </tr> </thead> <tbody> <tr><td>0</td><td>2400bps</td></tr> <tr><td>1</td><td>4800bps</td></tr> <tr><td>2</td><td>9600bps</td></tr> <tr><td>3</td><td>19200bps</td></tr> <tr><td>4</td><td>38400bps</td></tr> <tr><td>5</td><td>57600bps</td></tr> <tr><td>6</td><td>115200bps</td></tr> </tbody> </table> <table border="1"> <thead> <tr> <th colspan="2">Communicational protocol</th> </tr> </thead> <tbody> <tr><td>0</td><td>8, N, 1 (Modbus protocol, RTU mode)</td></tr> <tr><td>1</td><td>8, N, 2 (Modbus protocol, RTU mode)</td></tr> <tr><td>2</td><td>8, E, 1 (Modbus protocol, RTU mode)</td></tr> <tr><td>3</td><td>8, O, 1 (Modbus protocol, RTU mode)</td></tr> <tr><td>4</td><td>7, N, 2 (Modbus protocol, ASCII mode)</td></tr> <tr><td>5</td><td>7, E, 1 (Modbus protocol, ASCII mode)</td></tr> <tr><td>6</td><td>7, O, 1 (Modbus protocol, ASCII mode)</td></tr> <tr><td>7</td><td>8, N, 2 (Modbus protocol, ASCII mode)</td></tr> <tr><td>8</td><td>8, E, 1 (Modbus protocol, ASCII mode)</td></tr> <tr><td>9</td><td>8, O, 1 (Modbus protocol, ASCII mode)</td></tr> </tbody> </table> <p><b>Reserved</b></p> <table border="1"> <thead> <tr> <th colspan="2">Communicational data equivalent</th> </tr> </thead> <tbody> <tr><td>0</td><td>Internal speed: 1rpm; internal torque: 1% rated torque.</td></tr> <tr><td>1</td><td>Internal speed: 0.1rpm; internal torque: 0.1% rated torque.</td></tr> </tbody> </table>						RS485 bit rate		0	2400bps	1	4800bps	2	9600bps	3	19200bps	4	38400bps	5	57600bps	6	115200bps	Communicational protocol		0	8, N, 1 (Modbus protocol, RTU mode)	1	8, N, 2 (Modbus protocol, RTU mode)	2	8, E, 1 (Modbus protocol, RTU mode)	3	8, O, 1 (Modbus protocol, RTU mode)	4	7, N, 2 (Modbus protocol, ASCII mode)	5	7, E, 1 (Modbus protocol, ASCII mode)	6	7, O, 1 (Modbus protocol, ASCII mode)	7	8, N, 2 (Modbus protocol, ASCII mode)	8	8, E, 1 (Modbus protocol, ASCII mode)	9	8, O, 1 (Modbus protocol, ASCII mode)	Communicational data equivalent		0	Internal speed: 1rpm; internal torque: 1% rated torque.	1	Internal speed: 0.1rpm; internal torque: 0.1% rated torque.
RS485 bit rate																																																		
0	2400bps																																																	
1	4800bps																																																	
2	9600bps																																																	
3	19200bps																																																	
4	38400bps																																																	
5	57600bps																																																	
6	115200bps																																																	
Communicational protocol																																																		
0	8, N, 1 (Modbus protocol, RTU mode)																																																	
1	8, N, 2 (Modbus protocol, RTU mode)																																																	
2	8, E, 1 (Modbus protocol, RTU mode)																																																	
3	8, O, 1 (Modbus protocol, RTU mode)																																																	
4	7, N, 2 (Modbus protocol, ASCII mode)																																																	
5	7, E, 1 (Modbus protocol, ASCII mode)																																																	
6	7, O, 1 (Modbus protocol, ASCII mode)																																																	
7	8, N, 2 (Modbus protocol, ASCII mode)																																																	
8	8, E, 1 (Modbus protocol, ASCII mode)																																																	
9	8, O, 1 (Modbus protocol, ASCII mode)																																																	
Communicational data equivalent																																																		
0	Internal speed: 1rpm; internal torque: 1% rated torque.																																																	
1	Internal speed: 0.1rpm; internal torque: 0.1% rated torque.																																																	
PA017	Reserved	1~127		1																																														
PA018	Reserved	d.0000~0006		d.0003																																														
PA019	Reserved																																																	
PA020	Reserved																																																	

P	Descriptions	Range	Unit	Defau	Effective	R																							
PA021	<b>Analog output signal selection</b>	d.0000~0015		d.0000	Immed																								
	<p>The diagram shows four bits labeled 3, 2, 1, and 0. Bit 3 is connected to a 'Reserved' block. Bit 2 is connected to another 'Reserved' block. Bit 1 is connected to a table for 'Output voltage negation'. Bit 0 is connected to a table for 'Analog output signal selection'.</p> <table border="1"> <thead> <tr> <th colspan="2">Analog output signal selection</th> </tr> </thead> <tbody> <tr> <td>0</td> <td>Motor speed feedback</td> </tr> <tr> <td>1</td> <td>Motor torque feedback</td> </tr> </tbody> </table> <table border="1"> <thead> <tr> <th colspan="2">Output voltage negation</th> </tr> </thead> <tbody> <tr> <td>0</td> <td>Not negated</td> </tr> <tr> <td>1</td> <td>Negated</td> </tr> </tbody> </table>						Analog output signal selection		0	Motor speed feedback	1	Motor torque feedback	Output voltage negation		0	Not negated	1	Negated											
Analog output signal selection																													
0	Motor speed feedback																												
1	Motor torque feedback																												
Output voltage negation																													
0	Not negated																												
1	Negated																												
PA022	<b>Reserved</b>																												
PA023	<b>Analog voltage output gain</b>	0~65535		0	Immed																								
	The corresponding relations are as below:																												
	<table border="1"> <thead> <tr> <th>PA023</th> <th>Analog output data: speed</th> <th>When PA023≠0:</th> </tr> </thead> <tbody> <tr> <td>0</td> <td>500rpm = 1V, -1000rpm = -2V</td> <td rowspan="4">Output voltage = <math>\frac{\text{motor speed}}{\text{PA023}}</math></td> </tr> <tr> <td>500</td> <td>500rpm = 1V</td> </tr> <tr> <td>1000</td> <td>1000rpm = 1V</td> </tr> <tr> <td>250</td> <td>500rpm = 2V</td> </tr> </tbody> </table> <table border="1"> <thead> <tr> <th>PA023</th> <th>Analog output data: torque</th> <th>When PA023≠0:</th> </tr> </thead> <tbody> <tr> <td>0</td> <td>100% torque = 3V, -100% torque = -3V</td> <td rowspan="4">Output voltage = <math>\frac{\text{torque} \times 1000}{\text{PA023}}</math></td> </tr> <tr> <td>333</td> <td>100% torque = 3V, -100% torque = -3V</td> </tr> <tr> <td>222</td> <td>100% torque = 4.5V, -50%% torque = -2.25V</td> </tr> <tr> <td>666</td> <td>100% torque = 1.5V, -200%% torque = -3V</td> </tr> </tbody> </table>						PA023	Analog output data: speed	When PA023≠0:	0	500rpm = 1V, -1000rpm = -2V	Output voltage = $\frac{\text{motor speed}}{\text{PA023}}$	500	500rpm = 1V	1000	1000rpm = 1V	250	500rpm = 2V	PA023	Analog output data: torque	When PA023≠0:	0	100% torque = 3V, -100% torque = -3V	Output voltage = $\frac{\text{torque} \times 1000}{\text{PA023}}$	333	100% torque = 3V, -100% torque = -3V	222	100% torque = 4.5V, -50%% torque = -2.25V	666
PA023	Analog output data: speed	When PA023≠0:																											
0	500rpm = 1V, -1000rpm = -2V	Output voltage = $\frac{\text{motor speed}}{\text{PA023}}$																											
500	500rpm = 1V																												
1000	1000rpm = 1V																												
250	500rpm = 2V																												
PA023	Analog output data: torque	When PA023≠0:																											
0	100% torque = 3V, -100% torque = -3V	Output voltage = $\frac{\text{torque} \times 1000}{\text{PA023}}$																											
333	100% torque = 3V, -100% torque = -3V																												
222	100% torque = 4.5V, -50%% torque = -2.25V																												
666	100% torque = 1.5V, -200%% torque = -3V																												
PA024	<b>Analog voltage output zero calibration</b>	-8000~8000	mV	0	Immed																								
	PA024 is to calibrate zero voltage between voltage output & setting value.																												

P	Descriptions	Range	Unit	Defau	Effective	R							
PA025	<b>Basic function selection 12</b>	d.0000~0012		d.0000	Immed								
	<p>d. <input type="checkbox"/> <input type="checkbox"/> <input type="checkbox"/> <input type="checkbox"/></p> <table border="1"> <thead> <tr> <th colspan="2">Main circuit input power alarm selection</th> </tr> </thead> <tbody> <tr> <td>0</td> <td>If there is no high voltage (220VAC or 380VAC) input, no alarm will output, S-RDY invalid.</td> </tr> <tr> <td>1</td> <td>If there is no high voltage input within 1 second after power on, an alarm will output.</td> </tr> <tr> <td>2</td> <td>If there is high voltage input after power on, but power is lost with 1 second during operation, an alarm will output.</td> </tr> </tbody> </table> <p>Reserved</p> <p>Reserved</p> <p>Reserved</p>						Main circuit input power alarm selection		0	If there is no high voltage (220VAC or 380VAC) input, no alarm will output, S-RDY invalid.	1	If there is no high voltage input within 1 second after power on, an alarm will output.	2
Main circuit input power alarm selection													
0	If there is no high voltage (220VAC or 380VAC) input, no alarm will output, S-RDY invalid.												
1	If there is no high voltage input within 1 second after power on, an alarm will output.												
2	If there is high voltage input after power on, but power is lost with 1 second during operation, an alarm will output.												
PA100	<b>First position loop proportional gain</b>	1~1000	1/s	40	Immed								
	This parameter determines the responsiveness of position control systems. The higher this value, the shorter positioning time. But if this value is set too high, vibrations can be caused.												
PA101	<b>First speed loop proportional gain</b>	1~3000	Hz	40	Immed								
	This parameter determines the responsiveness of speed control loops. If PA100 is increased, PA101 also has to be increased accordingly. But if this value is set too high, vibrations can be caused.												
PA102	<b>First speed loop integral time constant</b>	1~2000	0.1 ms	200	Immed								
	The lower this value, the stronger integral effects & counter-interference effects. But if this value is set too high, vibrations can be caused.												
PA103	<b>First speed detection filter</b>	0~1000	0.01ms	10	Immed								
	This is the time constant of low pass filter. The higher this value, the higher time constant. This can reduce motor noise but will also reduce system responsiveness.												
PA104	<b>First torque filter</b>	0~1000	0.01ms	30	Immed								
	This is to set the first grade hysteresis filter time constant of the torque instructions and can regulate vibrations caused by distorted resonance. The higher this value, the higher time constant. This can reduce motor noise but will also reduce system responsiveness.												
PA105	<b>Second position loop proportional gain</b>	1~1000	1/s	40	Immed								
PA106	<b>Second speed loop proportional gain</b>	1~3000	Hz	80	Immed								
PA107	<b>Second speed loop integral time constant</b>	1~2000	0.1 ms	10	Immed								
PA108	<b>Second speed detection filter</b>	0~1000	0.01ms	5	Immed								

P	Descriptions	Range	Unit	Defau	Effective	R
PA109	<b>Second torque filter</b>	0~1000	0.01ms	20	Immed	
PA110	<b>Speed feedforward gain</b>	0~100	%	0	Immed	
The combination of the value of speed control instruction processed from position control, and the value of speed control instruction processed from internal position control multiplying this parameter.						
PA111	<b>Speed feedforward filter</b>	0~1000	0.1ms	0	Immed	
<b>This is to set the first grade hysteresis filter time constant of the speed feedforward.</b>						
PA114	<b>Friction compensation gain</b>	0~1000	0.1%	0	Immed	
PA115	<b>Friction compensation smoothness constant</b>	0~1000	0.1%	0	Immed	
PA116	<b>Friction compensation threshold speed</b>	0~3000	0.1rpm	100	Immed	
PA118	<b>Load inertia ratio</b>	0~5000	1%	200	Immed	
The ratio of load inertia to rotor inertia of the servo motor. $PA118 = (\text{load inertia/rotor inertia}) \times 100\%$ This parameter is invalid at automatic gain tuning.						
PA119	<b>Reserved</b>	0~32767	0.1ms	0		
PA120	<b>Gain switchover selection 1</b>	d.0000~0034		d.0000	Immed	

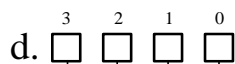

Mode switching condition selections	
0	Use internal torque instructions PA121
1	Use speed instructions PA122
2	Use accelerations PA123
3	Use position deviations PA124
4	No mode switching.

Reserved

Reserved

Reserved

P	Descriptions	Range	Unit	Defau	Effective	R
PA121	Mode switch (internal torque instructions)	0~300	1%	200	Immed	
PA122	Mode switch (speed instructions)	0~3000	1min-1	0	Immed	
PA123	Mode switch (accelerations)	0~65535	10rpm	0	Immed	
PA124	Mode switch (position deviations)	0~65535	1 pulse	0	Immed	
PA125	Gain switchover selection 2	d.0000~0092		d.0000	Immed	

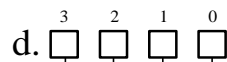

Gain switchover selections	
0	No gain switchover
1	Manual gain switchover
2	Automatic gain switchover: When gain switch condition A is valid, switch from 1 <sup>st</sup> gain to 2 <sup>nd</sup> gain. When gain switch condition A is invalid, switch from 2 <sup>nd</sup> gain to 1 <sup>st</sup> gain

Gain switchover condition A	
0	COIN is ON
1	COIN is OFF
2	NEAR is ON
3	NEAR is OFF
4	Position instruction filter output is 0 and instruction pulse input OFF
5	Position instruction pulse input ON
6	Torque instruction value is greater than PA126
7	Speed instruction value is greater than PA127
8	Speed instruction variation value is greater than PA128
9	Position deviation value is greater than PA129

**Reserved**

**Reserved**

PA126	Gain switchover grade (torque instruction)	0~300	1%	200	Immed	
PA127	Gain switchover grade (speed instruction)	0~3000	1 min-1	100	Immed	
PA128	Gain switchover grade (speed instruction variation)	0~65535	10rpm/s	10000	Immed	
PA129	Gain switchover grade (position deviation)	0~65535	1pulse	100	Immed	

P	Descriptions	Range	Unit	Defau	Effective	R
PA130	Gain switchover time 1	0~10000	0.1ms	10	Immed	
PA131	Gain switchover time 2	0~10000	0.1ms	10	Immed	
PA132	Gain switchover waiting time 1	0~10000	0.1ms	10	Immed	
PA133	Gain switchover waiting time 2	0~10000	0.1ms	10	Immed	
PA134	Reserved	0~10000		0		
PA137	Reserved	0~500		50		
PA138	Reserved	0~5000		0		
PA139	Reserved	0~10		0		
PA140	Reserved	0~5000		0		
PA200	Position control switch 1	d.0000~1232		d.0000	Restart	

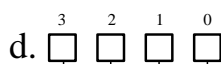

Input pulse form	
0	PULS + SIGN
1	CW + CCW
2	A phase + B phase (quadruple frequency)

Pulse (PULS+SIGN) negations	
0	Neither negates
1	PULS not negates, SIGN negates
2	PULS negates, SIGN not negates
3	Both negate

Position deviation clearance	
0	Clear position deviation when S-ON is off, power is off or by CLR signal.
1	Clear position deviation only by CLR. CLR also clears OT lock.
2	Clear position deviation only when servo has alarm or by CLR signal.

Input pulse channel	
0	Low speed channel (Pin 7/8, 11/12)
1	High speed channel (Pin 16/17, 23/24)

P	Descriptions	Range	Unit	Defau	Effective	R
PA201	Position control switch 2	d.0000~3177		d.0000	Restart	

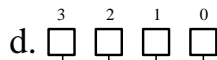

Low speed (pulse input) channel filter grade	
0~7	The higher this value, the longer filter time, the lower chop frequency. 0 means no filter.

High speed (pulse input) channel filter grade	
0~7	The higher this value, the longer filter time, the lower chop frequency. 0 means no filter.

AB pulse output negation	
0	Not negate.
1	Negate.

Z pulse output expansion	
0	No expansion. (Communicational type) encoder Z pulse width is defined by one A pulse width, i.e. the smaller the value of PA210, the wider Z pulse width.
1	Expand. (Non-communicational type) encoder Z pulse is A pulse width.

Relations between value of PA210.0 & I/O chop frequency

【PA201.0】	Chop frequency (KHz)	Remarks
0	500	<ul style="list-style-type: none"> <li>Check instruction pulse frequency by dP 14;</li> <li>Set value PA201.0 (not too) higher than dP 14.</li> </ul>
1	340	
2	170	
3	80	
4	40	
5	20	
6	10	
7	5	

P	Descriptions	Range	Unit	Defau	Effective	R
PA202	Position control switch 3	d.0000~9112		d.0000	Immed	

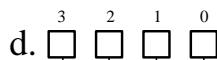

Positioning completion (COIN) signal output condition	
0	When position deviation is less than PA525.
1	When position deviation is less than PA525 AND position instruction is 0 after filtering.
2	When position deviation is less than PA525 and position instruction is 0.

External linear encoder signal negation in fully closed loop mode	
0	Not negate.
1	Negate.

Switchover between internal & external loops in fully closed loop mode	
0	C-MOD (0: external; 1: internal)
1	When electronic gear switch.(1:external; others:internal)

Pulse residual in fully closed loop mode	
0~9	When pulse residual is less than this value, fully closed loop control is finished.



P	Descriptions	Range	Unit	Defau	Effective	R
PA203	<b>Position control switch 4: Reserved</b>	d.0000~0022		d.0000	Restart	
PA204	<b>Reserved</b>					
PA205	<b>First electronic gear ratio numerator</b>	0~65535		1	Immed	
PA2	<b>Electronic gear ratio denominator</b>	0~65535		1	Immed	
PA207	<b>Second electronic gear ratio numerator</b>	0~65535		1	Immed	
PA208	<b>Third electronic gear ratio numerator</b>	0~65535		1	Immed	
PA209	<b>Fourth electronic gear ratio numerator</b>	0~65535		1	Immed	
PA210	<b>Encoder resolution (frequency-division) setting</b>	16~16384	1 Pulse /Rev	16384	Restart	
	<ul style="list-style-type: none"> <li>Encoder resolution is determined by number of OA or OB pulse output per revolution (multiplied by four). For example, if PA210=1000, when motor rotates 1 revolution, number of OA pulse output is 1000 and number of OB pulse output is also 1000.</li> <li>When value of PA210 exceeds number of encoder structural lines, this value becomes invalid and the actual number of encoder structure lines will be used. For example, if a 5000-line incremental encoder is used, and PA210 is set to 6000, the valid value is still 5000.</li> <li>For communicational encoders, Z pulse width is set to be the width of one A pulse. Thus the smaller PA210 value, the wider Z pulse given the same speed settings.</li> </ul>					
PA214	<b>Position instruction acceleration/deceleration time constant 1</b>	0~1000	0.1 ms	0	Immed	
PA215	<b>Position instruction acceleration/deceleration time constant 2</b>	0~1000	0.1 ms	0	Immed	
PA216	<b>Position instruction average-moving filter</b>	0~500	0.1 ms	0	Immed	

P	Descriptions	Range	Unit	Defau	Effective	R																								
PA300	Speed control switch 1	d.0000~1333		d.0200	Restart																									
PA300	<p>d. <input type="checkbox"/> <input type="checkbox"/> <input type="checkbox"/> <input type="checkbox"/></p> <p>3    2    1    0</p> <table border="1"> <thead> <tr> <th colspan="2">Speed instruction filter selection</th> </tr> </thead> <tbody> <tr> <td>0</td> <td>Linear filter</td> </tr> <tr> <td>1</td> <td>S-curve</td> </tr> <tr> <td>2</td> <td>First grade filter</td> </tr> </tbody> </table> <p>Reserved</p> <table border="1"> <thead> <tr> <th colspan="2">Manual load inertia detection operating distance</th> </tr> </thead> <tbody> <tr> <td>0</td> <td>1 turn</td> </tr> <tr> <td>1</td> <td>2 turns</td> </tr> <tr> <td>2</td> <td>4 turns</td> </tr> <tr> <td>3</td> <td>8 turns</td> </tr> </tbody> </table> <table border="1"> <thead> <tr> <th colspan="2">Speed dead zone control</th> </tr> </thead> <tbody> <tr> <td>0</td> <td>Use input signal: ZEROspd</td> </tr> <tr> <td>1</td> <td>Automatic: use PA316 setting</td> </tr> </tbody> </table>	Speed instruction filter selection		0	Linear filter	1	S-curve	2	First grade filter	Manual load inertia detection operating distance		0	1 turn	1	2 turns	2	4 turns	3	8 turns	Speed dead zone control		0	Use input signal: ZEROspd	1	Automatic: use PA316 setting					
Speed instruction filter selection																														
0	Linear filter																													
1	S-curve																													
2	First grade filter																													
Manual load inertia detection operating distance																														
0	1 turn																													
1	2 turns																													
2	4 turns																													
3	8 turns																													
Speed dead zone control																														
0	Use input signal: ZEROspd																													
1	Automatic: use PA316 setting																													
PA301	Speed instruction gain	150~30000	0.01 V /Rated speed	60 0	Immed																									
PA302	Speed instruction filter time constant	0~1000	0.1 ms	0	Immed																									
PA303	Soft start acceleration time	0~5000	1ms	0	Immed																									
PA304	Soft start deceleration time	0~5000	1ms	0	Immed																									
PA305	Speed instruction S-curve linear acceleration/deceleration time	0~5000	1ms	0	Immed																									
PA306	JOG speed	0~5000	1 min <sup>-1</sup>	500	Immed																									
PA307	Internal speed 0	-5000~ 5000	1 min <sup>-1</sup>	100	Immed																									
PA308	Internal speed 1	-5000~ 5000	1 min <sup>-1</sup>	200	Immed																									
PA309	Internal speed 2	-5000~ 5000	1 min <sup>-1</sup>	300	Immed																									
PA310	Internal speed 3	-5000~ 5000	1 min <sup>-1</sup>	400	Immed																									
PA311	Internal speed 4	-5000~ 5000	1 min <sup>-1</sup>	500	Immed																									
PA312	Internal speed 5	-5000~ 5000	1 min <sup>-1</sup>	600	Immed																									

P	Descriptions	Range	Unit	Defau	Effective	R
PA313	Internal speed 6	-5000~ 5000	1 min <sup>-1</sup>	700	Immed	
PA314	Internal speed 7	-5000~ 5000	1 min-1	800	Immed	
PA315	Speed control switch 2	0000~0012		0	Immed	

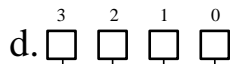

**Zero-speed clamp selection**

0	After the zero-speed clamp signal is active based on PA300.3, speed instruction is forced to be 0
1	After the zero-speed clamp signal is active based on PA300.3, speed instruction is forced to be 0 and when motor speed is below PA316, switch to position control mode and lock the servo in this position. When ZEROSPD signal is inactive or control mode is switched, exit this zero-speed clamp status.
2	After the zero-speed clamp signal is active based on PA300.3, decelerate at rate of PA522 and when motor speed is below PA316, switch to position control mode and lock the servo in this position. When ZEROSPD signal is inactive or control mode is switched, exit this zero-speed clamp status. This stop pattern is only suitable when PA300.0=0.

**Instruction source selection when INSPD2=INSPD1=INSPD0=0 in internal speed control**

0	PA307 setting
1	External analog input

**Reserved**

**Reserved**

PA316	Zero-speed clamp grade	1~2000	rpm	30	Immed	
PA317	Reserved					
PA318	Reserved					
PA400	Torque instruction gain	10~1000	0.1V /rated torque	30	Immed	
PA401	Torque instruction filter time constant	0~1000	0.1ms	0	Immed	
PA402	Forward rotation torque limit	0~300	1%	250	Immed	
PA403	Reverse rotation torque limit	0~300	1%	250	Immed	

P	Descriptions	Range	Unit	Defau	Effective	R															
PA404	<b>Forward rotation external torque limit</b>	0~100	1%	100	Immed																
PA405	<b>Reverse rotation external torque limit</b>	0~100	1%	100	Immed																
PA406	<b>Emergency stop torque</b>	0~300	1%	250	Immed																
PA407	<b>Speed limit in torque control mode</b>	0~5000	1 min <sup>-1</sup>	1500	Immed																
PA408	<b>Reserved</b>																				
PA409	<b>Torque instruction reached (VCMP)</b>	0~100	1%	2	Immed																
PA410	<b>Grade 1 notch filter frequency</b>	50~2000	1 Hz	2000	Immed																
PA411	<b>Grade 1 notch filter attenuation rate</b>	0~32	db	0	Immed																
PA412	<b>Grade 2 notch filter frequency</b>	50~2000	1 Hz	2000	Immed																
PA413	<b>Grade 2 notch filter attenuation rate</b>	0~32	db	0	Immed																
PA414	<b>Internal torque register 0</b>	-3000~3000	1%	0	Immed																
	<p>In torque control mode, when external I/O signals are INTor1 or INTor0, torque output will follow table below:</p> <table border="1"> <thead> <tr> <th>INTor1</th> <th>INTor0</th> <th>Torque control instruction</th> </tr> </thead> <tbody> <tr> <td>Invalid</td> <td>Invalid</td> <td>External analog input</td> </tr> <tr> <td>Invalid</td> <td>Valid</td> <td>Internal torque register 0</td> </tr> <tr> <td>Valid</td> <td>Invalid</td> <td>Internal torque register 1</td> </tr> <tr> <td>Valid</td> <td>Valid</td> <td>Internal torque register 2</td> </tr> </tbody> </table> <p>If PA016.3=1, the unit of PA414 is 0.1%, i.e. when PA414=100, corresponding internal torque is 10% of rated torque.</p>						INTor1	INTor0	Torque control instruction	Invalid	Invalid	External analog input	Invalid	Valid	Internal torque register 0	Valid	Invalid	Internal torque register 1	Valid	Valid	Internal torque register 2
INTor1	INTor0	Torque control instruction																			
Invalid	Invalid	External analog input																			
Invalid	Valid	Internal torque register 0																			
Valid	Invalid	Internal torque register 1																			
Valid	Valid	Internal torque register 2																			

P	Descriptions	Range	Unit	Defau	Effective	R												
PA415	<b>Internal torque register 1</b>	-3000~3000	1%	0	Immed													
PA416	<b>Internal torque register 2</b>	-3000~3000	1%	0	Immed													
PA417	<b>Reserved</b>																	
PA418	<b>Torque control switch 1</b>	d.0000~0011		d.0000	Immed													
	<p>d. <input type="checkbox"/> 3   <input type="checkbox"/> 2   <input type="checkbox"/> 1   <input type="checkbox"/> 0</p> <table border="1"> <thead> <tr> <th colspan="2">Deceleration control of speed limit in torque control mode</th> </tr> </thead> <tbody> <tr> <td>0</td> <td>No deceleration control</td> </tr> <tr> <td>1</td> <td>Use PA522 setting</td> </tr> </tbody> </table> <table border="1"> <thead> <tr> <th colspan="2">Torque compensation</th> </tr> </thead> <tbody> <tr> <td>0</td> <td>No torque compensation</td> </tr> <tr> <td>1</td> <td>Torque compensation in position or speed control mode. Compensation value is in accordance with torque instruction. (Analog input or internal torque registers)</td> </tr> </tbody> </table> <p><b>Reserved</b></p> <p><b>Reserved</b></p>						Deceleration control of speed limit in torque control mode		0	No deceleration control	1	Use PA522 setting	Torque compensation		0	No torque compensation	1	Torque compensation in position or speed control mode. Compensation value is in accordance with torque instruction. (Analog input or internal torque registers)
Deceleration control of speed limit in torque control mode																		
0	No deceleration control																	
1	Use PA522 setting																	
Torque compensation																		
0	No torque compensation																	
1	Torque compensation in position or speed control mode. Compensation value is in accordance with torque instruction. (Analog input or internal torque registers)																	
PA500	<b>DI 1 input signal selection</b>	0~50		0	Immed													
	<ul style="list-style-type: none"> <li>[0] Servo-on (S-ON)</li> <li>[1] Control mode switch (C-MODE)</li> <li>[2] Forward rotation prohibited (POT)</li> <li>[3] Reverse rotation prohibited (NOT)</li> <li>[4] Deviation counter clearance (CLR)</li> <li>[5] Alarm reset (A-RESTART)</li> <li>[6] Pulse input inhibited (INHIBIT)</li> <li>[7] Zero-speed clamp (ZEROSPD)</li> <li>[8] Forward torque limitation (PCL)</li> <li>[9] Reverse torque limitation (NCL)</li> <li>[10] Gain switch (GAIN)</li> <li>[11] Zero switch signal (ZPS)</li> <li>[12] Negation signal for internal position control &amp; internal speed control (CMDINV)</li> <li>[13] Instruction frequency division/ multiplication switch 0 (DIV0)</li> <li>[14] Instruction frequency division/ multiplication switch 1 (DIV1)</li> <li>[15] Internal speed register 0 (INSPD0)</li> <li>[16] Internal speed register 1 (INSPD1)</li> <li>[17] Internal speed register 2 (INSPD2)</li> </ul>																	

P	Descriptions	Range	Unit	Defau	Effective	R
	[18] Internal position register 0 (INPOS0) [19] Internal position register 1 (INPOS1) [20] Internal position register 2 (INPOS2) [21] Internal position register 3 (INPOS3) [22] Internal position control trigger (PTRG) [23] Internal position control Forward JOG (P-POS) [24] Internal position control Reverse JOG (N-POS) [25] Internal position control homing start (SHOME) [26] Internal position control stops (PZERO) [28] Internal torque register 0 (INTor0) [29] Internal torque register 1 (INTor1) [30] Incremental/Absolute mode selection in internal position control mode (PAbs) [OTHER] invalid					
PA501	<b>DI 2 input signal selection (same as PA500)</b>	0~50		1	Immed	
PA502	<b>DI 3 input signal selection (same as PA500)</b>	0~50		2	Immed	
PA503	<b>DI 4 input signal selection (same as PA500)</b>	0~50		3	Immed	
PA504	<b>DI 5 input signal selection (same as PA500)</b>	0~50		4	Immed	
PA505	<b>DI 6 input signal selection (same as PA500)</b>	0~50		5	Immed	
PA506	<b>DI 7 input signal selection (same as PA500)</b>	0~50		6	Immed	
PA507	<b>DI 8 input signal selection (same as PA500)</b>	0~50		7	Immed	
PA508	<b>Input signal level selection 1</b>	b.0000~1111		b.0000	Immed	

P	Descriptions	Range	Unit	Defau	Effective	R																
	<p>b. <input type="checkbox"/> <sup>3</sup> <input type="checkbox"/> <sup>2</sup> <input type="checkbox"/> <sup>1</sup> <input type="checkbox"/> <sup>0</sup></p> <p><b>DI 1 input signal level selection</b></p> <table border="1"> <tr><td>0</td><td>L level active (optocoupler conductive)</td></tr> <tr><td>1</td><td>H level active (optocoupler not conductive)</td></tr> </table> <p><b>DI 2 input signal level selection</b></p> <table border="1"> <tr><td>0</td><td>L level active (optocoupler conductive)</td></tr> <tr><td>1</td><td>H level active (optocoupler not conductive)</td></tr> </table> <p><b>DI 3 input signal level selection</b></p> <table border="1"> <tr><td>0</td><td>L level active (optocoupler conductive)</td></tr> <tr><td>1</td><td>H level active (optocoupler not conductive)</td></tr> </table> <p><b>DI 4 input signal level selection</b></p> <table border="1"> <tr><td>0</td><td>L level active (optocoupler conductive)</td></tr> <tr><td>1</td><td>H level active (optocoupler not conductive)</td></tr> </table>	0	L level active (optocoupler conductive)	1	H level active (optocoupler not conductive)	0	L level active (optocoupler conductive)	1	H level active (optocoupler not conductive)	0	L level active (optocoupler conductive)	1	H level active (optocoupler not conductive)	0	L level active (optocoupler conductive)	1	H level active (optocoupler not conductive)					
0	L level active (optocoupler conductive)																					
1	H level active (optocoupler not conductive)																					
0	L level active (optocoupler conductive)																					
1	H level active (optocoupler not conductive)																					
0	L level active (optocoupler conductive)																					
1	H level active (optocoupler not conductive)																					
0	L level active (optocoupler conductive)																					
1	H level active (optocoupler not conductive)																					
PAS09	<b>Input signal level selection 2</b>	b.0000~1111		b.0000	Immed																	
	<p>b. <input type="checkbox"/> <sup>3</sup> <input type="checkbox"/> <sup>2</sup> <input type="checkbox"/> <sup>1</sup> <input type="checkbox"/> <sup>0</sup></p> <p><b>DI 5 input signal level selection</b></p> <table border="1"> <tr><td>0</td><td>L level active (optocoupler conductive)</td></tr> <tr><td>1</td><td>H level active (optocoupler not conductive)</td></tr> </table> <p><b>DI 6 input signal level selection</b></p> <table border="1"> <tr><td>0</td><td>L level active (optocoupler conductive)</td></tr> <tr><td>1</td><td>H level active (optocoupler not conductive)</td></tr> </table> <p><b>DI 7 input signal level selection</b></p> <table border="1"> <tr><td>0</td><td>L level active (optocoupler conductive)</td></tr> <tr><td>1</td><td>H level active (optocoupler not conductive)</td></tr> </table> <p><b>DI 8 input signal level selection</b></p> <table border="1"> <tr><td>0</td><td>L level active (optocoupler conductive)</td></tr> <tr><td>1</td><td>H level active (optocoupler not conductive)</td></tr> </table>	0	L level active (optocoupler conductive)	1	H level active (optocoupler not conductive)	0	L level active (optocoupler conductive)	1	H level active (optocoupler not conductive)	0	L level active (optocoupler conductive)	1	H level active (optocoupler not conductive)	0	L level active (optocoupler conductive)	1	H level active (optocoupler not conductive)					
0	L level active (optocoupler conductive)																					
1	H level active (optocoupler not conductive)																					
0	L level active (optocoupler conductive)																					
1	H level active (optocoupler not conductive)																					
0	L level active (optocoupler conductive)																					
1	H level active (optocoupler not conductive)																					
0	L level active (optocoupler conductive)																					
1	H level active (optocoupler not conductive)																					
PAS10	<b>Output signal selection</b>	h.0000~DDD D		h.3210	Immed																	

P	Descriptions	Range	Unit	Defau	Effective	R																																		
PAS11	<p>h. <input type="checkbox"/> 3 <input type="checkbox"/> 2 <input type="checkbox"/> 1 <input type="checkbox"/> 0</p> <p><b>DO 1 output signal selection</b></p> <table border="1"> <tr><td>0</td><td>Alarm signal output (ALM)</td></tr> <tr><td>1</td><td>Positioning completed (COIN): position deviation is less than PA525.</td></tr> <tr><td>2</td><td>Z pulse open-collector signal (CZ)</td></tr> <tr><td>3</td><td>Brake release signal (BK): can be adjusted by PA518.</td></tr> <tr><td>4</td><td>Servo ready signal (S-RDY): active when servo is in proper status.</td></tr> <tr><td>5</td><td>Speed instruction reached (VCMP): speed deviation is less than PA517.</td></tr> <tr><td>6</td><td>Motor rotation detection (TGON): active when rotational speed exceeds PA516.</td></tr> <tr><td>7</td><td>Torque limited signal (TLC): active when load torque reaches PA402/PA403.</td></tr> <tr><td>8</td><td>Zero-speed detection signal (ZSP): active when rotational speed is less than PA515.</td></tr> <tr><td>9</td><td>Warning output (WARN)</td></tr> <tr><td>A</td><td>Internal position control homing completion signal (HOME)</td></tr> <tr><td>B</td><td>Internal position control position instruction completion signal (CMD-OK)</td></tr> <tr><td>C</td><td>Internal position control positioning &amp; command completion signal (MC-OK)</td></tr> <tr><td>D</td><td>Torque reached (TREACH): load torque exceeds PA404 or PA405.</td></tr> </table> <p><b>DO 2 output signal selection</b></p> <table border="1"> <tr><td>0~D</td><td>same allocation method as DO 1</td></tr> </table> <p><b>DO 3 output signal selection</b></p> <table border="1"> <tr><td>0~D</td><td>same allocation method as DO 1</td></tr> </table> <p><b>DO 4 output signal selection</b></p> <table border="1"> <tr><td>0~D</td><td>same allocation method as DO 1</td></tr> </table>	0	Alarm signal output (ALM)	1	Positioning completed (COIN): position deviation is less than PA525.	2	Z pulse open-collector signal (CZ)	3	Brake release signal (BK): can be adjusted by PA518.	4	Servo ready signal (S-RDY): active when servo is in proper status.	5	Speed instruction reached (VCMP): speed deviation is less than PA517.	6	Motor rotation detection (TGON): active when rotational speed exceeds PA516.	7	Torque limited signal (TLC): active when load torque reaches PA402/PA403.	8	Zero-speed detection signal (ZSP): active when rotational speed is less than PA515.	9	Warning output (WARN)	A	Internal position control homing completion signal (HOME)	B	Internal position control position instruction completion signal (CMD-OK)	C	Internal position control positioning & command completion signal (MC-OK)	D	Torque reached (TREACH): load torque exceeds PA404 or PA405.	0~D	same allocation method as DO 1	0~D	same allocation method as DO 1	0~D	same allocation method as DO 1					
	0	Alarm signal output (ALM)																																						
	1	Positioning completed (COIN): position deviation is less than PA525.																																						
	2	Z pulse open-collector signal (CZ)																																						
3	Brake release signal (BK): can be adjusted by PA518.																																							
4	Servo ready signal (S-RDY): active when servo is in proper status.																																							
5	Speed instruction reached (VCMP): speed deviation is less than PA517.																																							
6	Motor rotation detection (TGON): active when rotational speed exceeds PA516.																																							
7	Torque limited signal (TLC): active when load torque reaches PA402/PA403.																																							
8	Zero-speed detection signal (ZSP): active when rotational speed is less than PA515.																																							
9	Warning output (WARN)																																							
A	Internal position control homing completion signal (HOME)																																							
B	Internal position control position instruction completion signal (CMD-OK)																																							
C	Internal position control positioning & command completion signal (MC-OK)																																							
D	Torque reached (TREACH): load torque exceeds PA404 or PA405.																																							
0~D	same allocation method as DO 1																																							
0~D	same allocation method as DO 1																																							
0~D	same allocation method as DO 1																																							
PAS11	<b>Output signal level selection</b>	b.0000~1111		b.0000	Immed																																			
PAS11	<p>b. <input type="checkbox"/> 3 <input type="checkbox"/> 2 <input type="checkbox"/> 1 <input type="checkbox"/> 0</p> <p><b>DO 1 output signal level selection</b></p> <table border="1"> <tr><td>0</td><td>H level active (optocoupler not conductive)</td></tr> <tr><td>1</td><td>L level active (optocoupler conductive)</td></tr> </table> <p><b>DO 2 output signal level selection</b></p> <table border="1"> <tr><td>0</td><td>L level active (optocoupler conductive)</td></tr> <tr><td>1</td><td>H level active (optocoupler not conductive)</td></tr> </table> <p><b>DO 3 output signal level selection</b></p> <table border="1"> <tr><td>0</td><td>L level active (optocoupler conductive)</td></tr> <tr><td>1</td><td>H level active (optocoupler not conductive)</td></tr> </table> <p><b>DO 4 output signal level selection</b></p> <table border="1"> <tr><td>0</td><td>L level active (optocoupler conductive)</td></tr> <tr><td>1</td><td>H level active (optocoupler not conductive)</td></tr> </table>	0	H level active (optocoupler not conductive)	1	L level active (optocoupler conductive)	0	L level active (optocoupler conductive)	1	H level active (optocoupler not conductive)	0	L level active (optocoupler conductive)	1	H level active (optocoupler not conductive)	0	L level active (optocoupler conductive)	1	H level active (optocoupler not conductive)																							
	0	H level active (optocoupler not conductive)																																						
	1	L level active (optocoupler conductive)																																						
	0	L level active (optocoupler conductive)																																						
1	H level active (optocoupler not conductive)																																							
0	L level active (optocoupler conductive)																																							
1	H level active (optocoupler not conductive)																																							
0	L level active (optocoupler conductive)																																							
1	H level active (optocoupler not conductive)																																							
PAS12	<b>Input signal filter time (DC bus voltage compensation)</b>	1~1000	1ms	10	Immed																																			
PAS13	<b>Serial encoder communicational alarm time</b>	1~100	0.1ms	5	Immed																																			



P	Descriptions	Range	Unit	Defau	Effective	R
PA514	<b>Reserved</b>					
PA515	<b>Zero position fixed value</b>	0~3000	1 min <sup>-1</sup>	10	Immed	
PA516	<b>Rotation detection value</b>	1~3000	1 min <sup>-1</sup>	20	Immed	
PA517	<b>VCMP signal detection width</b>	1~100	1 min <sup>-1</sup>	10	Immed	
PA518	<b>BK signal hysteresis time after Servo-OFF</b>	0~500	1 ms	100	Immed	
PA519	<b>BK signal speed limit</b>	0~1000	1 min <sup>-1</sup>	100	Immed	
PA520	<b>BK signal waiting time at Servo-OFF</b>	100~1000	1 ms	500	Immed	
PA521	<b>Instantaneous power off holding time</b>	40~800	1ms	60	Immed	
PA522	<b>Deceleration at Servo OFF</b> <ul style="list-style-type: none"> <li>PA522=1000: deceleration time for motor from 1000rpm to 0rpm is 1000ms</li> <li>PA522=200: deceleration time for motor from 200rpm to 0rpm is 400ms (200ms*2)</li> </ul>	0~5000	1ms	100	Immed	
PA523	<b>Servo OFF stop threshold</b>	20~2000	rpm	50	Immed	
PA525	<b>COIN signal width</b>	0~65535	pulse	10	Immed	
PA526	<b>NEAR signal width</b>	0~65535	4 pulses	100	Immed	
PA527	<b>Position over-deviation WARN threshold at S-ON</b>	1~65535	0.01r	200	Immed	
	Encoder resolution shall be taken into calculations. For example, if the encoder resolution is 20,000ppr, the unit of this value is 200 pulses (20000*0.01) and by default, the WARN value is 200*200=40000 pulses.					
PA528	<b>Position over-deviation ERR threshold at S-ON</b>	1~65535	0.01r	500	Immed	
PA529	<b>Speed deviation ERR detection time</b>	20~2000	1ms	300	Immed	

P	Descriptions	Range	Unit	Defau	Effective	R												
PA530	<b>Speed deviation ERR threshold grade</b>	0~10		5	Immed													
	If speed deviation exceeds this threshold, E.28 will output. If PA530=10, speed deviation ERR is disabled.																	
PA531	<b>Overload WARN threshold</b>	5~100	%	50	Immed													
PA532	<b>Speed increment threshold</b>	0~1000	rpm	0	Immed													
PA533	<b>ALM clearance input setting</b>	0~3		0	Immed													
PA534	<b>Main power off detection time</b>	100~2000	1ms	100	Immed													
	This is the detection time when main power off status continues. If PA534=2000, main power off detection is disabled.																	
PA535	<b>Special switch 1</b>	b.0000~1111		b.0000	Immed													
<p>b. <input type="checkbox"/> <input type="checkbox"/> <input type="checkbox"/> <input type="checkbox"/></p> <p>3      2      1      0</p> <table border="1"> <tr> <th colspan="2">ADC detection at power on</th> </tr> <tr> <td>0</td> <td>Detect.</td> </tr> <tr> <td>1</td> <td>Not detect.</td> </tr> </table> <table border="1"> <tr> <th colspan="2">Torque limit at stop</th> </tr> <tr> <td>0</td> <td>Invalid.</td> </tr> <tr> <td>1</td> <td>Torque limit at stop is PA404 &amp; PA405.</td> </tr> </table> <p>Reserved</p> <p>Reserved</p>							ADC detection at power on		0	Detect.	1	Not detect.	Torque limit at stop		0	Invalid.	1	Torque limit at stop is PA404 & PA405.
ADC detection at power on																		
0	Detect.																	
1	Not detect.																	
Torque limit at stop																		
0	Invalid.																	
1	Torque limit at stop is PA404 & PA405.																	
PA536	<b>High voltage compensation of pumping process</b>	-20~20	V	-5	Immed													
PA537	<b>Resistance of external regenerative resistor</b>	5~200	Ohm	30	Restart													
PA538	<b>Capacity of external regenerative resistor</b>	20~3000	Watt	60	Restart													
PA542	<b>Low voltage compensation of pumping process</b>	-20~20	V	5	Immed													
PA543	<b>IGBT temperature adjustment amplitude</b>	-20~20	°C	0	Immed													

P	Descriptions	Range	Unit	Defau	Effective	R																				
PA544	Dynamic brake (DB) start time	0~1000	0.1ms	500	Immed																					
PA545	S-RDY time	0~1000	1ms	10	Immed																					
PA600	Adjustment switch 1	h.0000~03F6		h.0220	Restart																					
<p>d. <input type="checkbox"/> <input type="checkbox"/> <input type="checkbox"/> <input type="checkbox"/></p> <p>3      2      1      0</p> <table border="1"> <thead> <tr> <th colspan="2">Auto-tuning selection</th> </tr> </thead> <tbody> <tr> <td>0</td> <td>Invalid</td> </tr> <tr> <td>1</td> <td>Valid</td> </tr> </tbody> </table> <table border="1"> <thead> <tr> <th colspan="2">Load inertia estimation pace at auto-tuning</th> </tr> </thead> <tbody> <tr> <td>0~F</td> <td>The larger this value, the faster auto-tuning pace but the less accurate.</td> </tr> </tbody> </table> <table border="1"> <thead> <tr> <th colspan="2">Load inertia estimation pattern selection</th> </tr> </thead> <tbody> <tr> <td>0</td> <td>Invalid.</td> </tr> <tr> <td>1</td> <td>Minor change. When load inertia changes, respond with minute instructions.</td> </tr> <tr> <td>2</td> <td>Small change. When load inertia changes, respond with second instructions.</td> </tr> <tr> <td>3</td> <td>Drastic change. When load inertia changes, respond with the fastest instructions.</td> </tr> </tbody> </table> <p>Reserved</p>							Auto-tuning selection		0	Invalid	1	Valid	Load inertia estimation pace at auto-tuning		0~F	The larger this value, the faster auto-tuning pace but the less accurate.	Load inertia estimation pattern selection		0	Invalid.	1	Minor change. When load inertia changes, respond with minute instructions.	2	Small change. When load inertia changes, respond with second instructions.	3	Drastic change. When load inertia changes, respond with the fastest instructions.
Auto-tuning selection																										
0	Invalid																									
1	Valid																									
Load inertia estimation pace at auto-tuning																										
0~F	The larger this value, the faster auto-tuning pace but the less accurate.																									
Load inertia estimation pattern selection																										
0	Invalid.																									
1	Minor change. When load inertia changes, respond with minute instructions.																									
2	Small change. When load inertia changes, respond with second instructions.																									
3	Drastic change. When load inertia changes, respond with the fastest instructions.																									
PA601	Reserved	0000~0512		0000																						
PA602	Reserved	0000~1111		0000																						
PA603	Adjustment switch 4	b.0000~1111		b.0010	Immed																					
<p>b. <input type="checkbox"/> <input type="checkbox"/> <input type="checkbox"/> <input type="checkbox"/></p> <p>3      2      1      0</p> <table border="1"> <thead> <tr> <th colspan="2">PA118 (load inertia ratio) adjustment after load inertia detection</th> </tr> </thead> <tbody> <tr> <td>0</td> <td>Automatic adjustment</td> </tr> <tr> <td>1</td> <td>Manual adjustment</td> </tr> </tbody> </table> <table border="1"> <thead> <tr> <th colspan="2">Load inertia value at auto-tuning</th> </tr> </thead> <tbody> <tr> <td>0</td> <td>Use estimated value</td> </tr> <tr> <td>1</td> <td>Use PA118 value</td> </tr> </tbody> </table> <p>Reserved</p> <p>Reserved</p>							PA118 (load inertia ratio) adjustment after load inertia detection		0	Automatic adjustment	1	Manual adjustment	Load inertia value at auto-tuning		0	Use estimated value	1	Use PA118 value								
PA118 (load inertia ratio) adjustment after load inertia detection																										
0	Automatic adjustment																									
1	Manual adjustment																									
Load inertia value at auto-tuning																										
0	Use estimated value																									
1	Use PA118 value																									
PA604	Reserved	0000~1111		0000																						

P	Descriptions	Range	Unit	Defau	Effective	R																
PA605	Reserved	0000~0003		0000																		
PA606	Inertia stabilization criteria	0~100		2	Immed																	
	When estimated inertia is less than [PA606*motor inertia] and this lasts for a certain period of time, user can determine end of inertia estimation.																					
PA608	Reserved	0~100	1%	0																		
PA609	Reserved	0~1000	0.01ms	100																		
PA610	Bandwidth setting at auto-tuning	1~1000	Hz	40	Immed																	
	The larger this value, the faster the response and the greater the rigidity, but the higher possibility of vibration.																					
PA612	Reserved	0~9		0																		
PA613	Reserved	0~1000	0.1ms	10																		
PA700	Internal position control switch 1	h.0000~FF02		h.1002	Immed																	
	<p>h. <input type="checkbox"/> <input type="checkbox"/> <input type="checkbox"/> <input type="checkbox"/></p> <p><b>Internal position running pattern</b></p> <table border="1"> <tr><td>0</td><td>INPOS selects internal position section; PTRG trigger.</td></tr> <tr><td>1</td><td>Internal position runs in cycles but each position needs PTRG signal. (Step by step)</td></tr> <tr><td>2</td><td>Internal position runs in cycles at internal timing automatically.</td></tr> </table> <p><b>Incremental or absolute position selection</b></p> <table border="1"> <tr><td>0</td><td>Incremental position</td></tr> <tr><td>1</td><td>Absolute position</td></tr> <tr><td>2</td><td>PAbs selects incremental or absolute position.</td></tr> </table> <p><b>Cycle run starting position</b></p> <table border="1"> <tr><td>0~F</td><td>To select the starting position</td></tr> </table> <p><b>Cycle run ending position</b></p> <table border="1"> <tr><td>0~F</td><td>To select the ending position</td></tr> </table>						0	INPOS selects internal position section; PTRG trigger.	1	Internal position runs in cycles but each position needs PTRG signal. (Step by step)	2	Internal position runs in cycles at internal timing automatically.	0	Incremental position	1	Absolute position	2	PAbs selects incremental or absolute position.	0~F	To select the starting position	0~F	To select the ending position
0	INPOS selects internal position section; PTRG trigger.																					
1	Internal position runs in cycles but each position needs PTRG signal. (Step by step)																					
2	Internal position runs in cycles at internal timing automatically.																					
0	Incremental position																					
1	Absolute position																					
2	PAbs selects incremental or absolute position.																					
0~F	To select the starting position																					
0~F	To select the ending position																					
PA701	Internal position 0 distance low place	h.0000~FFFF	pulse	h.4E20	Immed																	

P	Descriptions	Range	Unit	Defau	Effective	R
PA702	Internal position 0 distance high place	h.0000~FFFF		h.0000	Immed	
PA703	Internal position 1 distance low place	h.0000~FFFF	pulse	h.9C40	Immed	
PA704	Internal position 1 distance high place	h.0000~FFFF		h.0000	Immed	
PA705	Internal position 2 distance low place	h.0000~FFFF	pulse	h.EA60	Immed	
PA706	Internal position 2 distance high place	h.0000~FFFF		h.0000	Immed	
PA707	Internal position 3 distance low place	h.0000~FFFF	pulse	h.3880	Immed	
PA708	Internal position 3 distance high place	h.0000~FFFF		h.0001	Immed	
PA709	Internal position 4 distance low place	h.0000~FFFF	pulse	h.86A0	Immed	
PA710	Internal position 4 distance high place	h.0000~FFFF		h.0001	Immed	
PA711	Internal position 5 distance low place	h.0000~FFFF	pulse	h.D4C0	Immed	
PA712	Internal position 5 distance high place	h.0000~FFFF		h.0001	Immed	
PA713	Internal position 6 distance low place	h.0000~FFFF	pulse	h.22E0	Immed	
PA714	Internal position 6 distance high place	h.0000~FFFF		h.0002	Immed	
PA715	Internal position 7 distance low place	h.0000~FFFF	pulse	h.7100	Immed	
PA716	Internal position 7 distance high place	h.0000~FFFF		h.0002	Immed	
PA717	Internal position 8 distance low place	h.0000~FFFF	pulse	h.BF20	Immed	
PA718	Internal position 8 distance high place	h.0000~FFFF		h.0002	Immed	

P	Descriptions	Range	Unit	Defau	Effective	R
PA719	Internal position 9 distance low place	h.0000~FFFF	pulse	h.0D40	Immed	
PA720	Internal position 9 distance high place	h.0000~FFFF		h.0003	Immed	
PA721	Internal position 10 distance low place	h.0000~FFFF	pulse	h.5B60	Immed	
PA722	Internal position 10 distance high place	h.0000~FFFF		h.0003	Immed	
PA723	Internal position 11 distance low place	h.0000~FFFF	pulse	h.A980	Immed	
PA724	Internal position 11 distance high place	h.0000~FFFF		h.0003	Immed	
PA725	Internal position 12 distance low place	h.0000~FFFF	pulse	h.F7A0	Immed	
PA726	Internal position 12 distance high place	h.0000~FFFF		h.0003	Immed	
PA727	Internal position 13 distance low place	h.0000~FFFF	pulse	h.45C0	Immed	
PA728	Internal position 13 distance high place	h.0000~FFFF		h.0004	Immed	
PA729	Internal position 14 distance low place	h.0000~FFFF	pulse	h.93E0	Immed	
PA730	Internal position 14 distance high place	h.0000~FFFF		h.0004	Immed	
PA731	Internal position 15 distance low place	h.0000~FFFF	pulse	h.E200	Immed	
PA732	Internal position 15 distance high place	h.0000~FFFF		h.0004	Immed	
PA733	Internal position 0 speed	0~5000	1 min-1	100	Immed	
PA734	Internal position 1 speed	0~5000	1 min-1	100	Immed	
PA735	Internal position 2 speed	0~5000	1 min-1	100	Immed	

P	Descriptions	Range	Unit	Defau	Effective	R
PA736	Internal position 3 speed	0~5000	1 min-1	100	Immed	
PA737	Internal position 4 speed	0~5000	1 min-1	100	Immed	
PA738	Internal position 5 speed	0~5000	1 min-1	100	Immed	
PA739	Internal position 6 speed	0~5000	1 min-1	100	Immed	
PA740	Internal position 7 speed	0~5000	1 min-1	100	Immed	
PA741	Internal position 8 speed	0~5000	1 min-1	100	Immed	
PA742	Internal position 9 speed	0~5000	1 min-1	100	Immed	
PA743	Internal position 10 speed	0~5000	1 min-1	100	Immed	
PA744	Internal position 11 speed	0~5000	1 min-1	100	Immed	
PA745	Internal position 12 speed	0~5000	1 min-1	100	Immed	
PA746	Internal position 13 speed	0~5000	1 min-1	100	Immed	
PA747	Internal position 14 speed	0~5000	1 min-1	100	Immed	
PA748	Internal position 15 speed	0~5000	1 min-1	100	Immed	
PA749	Internal position 0 acceleration/deceleration time	0~500	ms	0	Immed	
PA750	Internal position 1 acceleration/deceleration time	0~500	ms	0	Immed	
PA751	Internal position 2 acceleration/deceleration time	0~500	ms	0	Immed	
PA752	Internal position 3 acceleration/deceleration time	0~500	ms	0	Immed	

P	Descriptions	Range	Unit	Defau	Effective	R
PA753	Internal position 4 acceleration/deceleration time	0~500	ms	0	Immed	
PA754	Internal position 5 acceleration/deceleration time	0~500	ms	0	Immed	
PA755	Internal position 6 acceleration/deceleration time	0~500	ms	0	Immed	
PA756	Internal position 7 acceleration/deceleration time	0~500	ms	0	Immed	
PA757	Internal position 8 acceleration/deceleration time	0~500	ms	0	Immed	
PA758	Internal position 9 acceleration/deceleration time	0~500	ms	0	Immed	
PA759	Internal position 10 acceleration/deceleration time	0~500	ms	0	Immed	
PA760	Internal position 11 acceleration/deceleration time	0~500	ms	0	Immed	
PA761	Internal position 12 acceleration/deceleration time	0~500	ms	0	Immed	
PA762	Internal position 13 acceleration/deceleration time	0~500	ms	0	Immed	
PA763	Internal position 14 acceleration/deceleration time	0~500	ms	0	Immed	
PA764	Internal position 15 acceleration/deceleration time	0~500	ms	0	Immed	
PA765	Internal position dead zone time	0~65535	ms	100	Immed	
PA766	Position demonstration low place	h.0000~FFFF	pulse	0	Immed	
PA767	Position demonstration high place	h.0000~FFFF		0	Immed	
PA768	JOG speed in internal position control mode	0~5000	rpm	100	Immed	
PA769	Switch of incremental/absolute position in internal position control mode	0~65535	--	0	Immed	

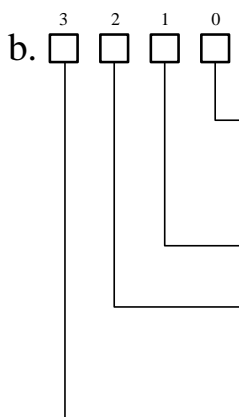
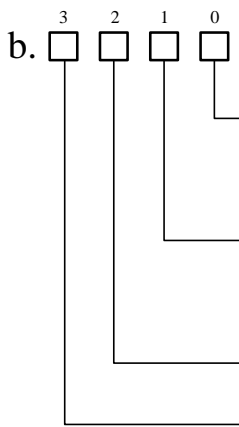

P	Descriptions	Range	Unit	Defau	Effective	R																											
	<p>Incremental/absolute positions are determined by corresponding binary data:</p> <table border="1"> <tr> <td>Position 15</td> <td>Position 14</td> <td></td> <td>Position 2</td> <td>Position 1</td> <td>Position 0</td> </tr> <tr> <td>BIT15</td> <td>BIT14</td> <td>...</td> <td>BIT2</td> <td>BIT1</td> <td>BIT0</td> </tr> </table> <ul style="list-style-type: none"> <li>If the corresponding binary data is 0, this position is incremental</li> <li>If the corresponding binary data is 1, this position is absolute.</li> </ul> <p>For example, PA769=4, in binary this is 0000, 0000, 0000, 0100. Only BIT2 is 1, thus position 2 is absolute and all other positions are incremental.</p> <p>To use this parameter, PA700.1 must be set to 0 and PAbs signal shall not be used.</p>	Position 15	Position 14		Position 2	Position 1	Position 0	BIT15	BIT14	...	BIT2	BIT1	BIT0																				
Position 15	Position 14		Position 2	Position 1	Position 0																												
BIT15	BIT14	...	BIT2	BIT1	BIT0																												
PA770	<b>Internal position control switch 2</b>	b.0000~1111		b.0000	Immed																												
	<p>b.</p> <table border="1"> <tr> <td>3</td> <td>2</td> <td>1</td> <td>0</td> </tr> <tr> <td><input type="checkbox"/></td> <td><input type="checkbox"/></td> <td><input type="checkbox"/></td> <td><input type="checkbox"/></td> </tr> </table> <p><b>Trigger signal selection</b></p> <table border="1"> <tr> <td>0</td> <td>Use PTRG</td> </tr> <tr> <td>1</td> <td>Use internal position selection signals: INPOS0, INPOS1, INPOS2, INPOS3</td> </tr> </table> <p><b>Trigger time sequence selection</b></p> <table border="1"> <tr> <td>0</td> <td>Only receive new trigger signal when current position is completed (CMD-OK)</td> </tr> <tr> <td>1</td> <td>Can receive new trigger even though current position is not completed</td> </tr> </table> <p><b>PZERO function selection</b></p> <table border="1"> <tr> <td>0</td> <td>Stop.</td> </tr> <tr> <td>1</td> <td>Pause.</td> </tr> </table> <p><b>Software limit switch selection</b></p> <table border="1"> <tr> <td>0</td> <td>Invalid. No software limit switch.</td> </tr> <tr> <td>1</td> <td>Valid. PA756, PA757 are positive limits; PA758, PA759 are negative limits.</td> </tr> </table>	3	2	1	0	<input type="checkbox"/>	<input type="checkbox"/>	<input type="checkbox"/>	<input type="checkbox"/>	0	Use PTRG	1	Use internal position selection signals: INPOS0, INPOS1, INPOS2, INPOS3	0	Only receive new trigger signal when current position is completed (CMD-OK)	1	Can receive new trigger even though current position is not completed	0	Stop.	1	Pause.	0	Invalid. No software limit switch.	1	Valid. PA756, PA757 are positive limits; PA758, PA759 are negative limits.								
3	2	1	0																														
<input type="checkbox"/>	<input type="checkbox"/>	<input type="checkbox"/>	<input type="checkbox"/>																														
0	Use PTRG																																
1	Use internal position selection signals: INPOS0, INPOS1, INPOS2, INPOS3																																
0	Only receive new trigger signal when current position is completed (CMD-OK)																																
1	Can receive new trigger even though current position is not completed																																
0	Stop.																																
1	Pause.																																
0	Invalid. No software limit switch.																																
1	Valid. PA756, PA757 are positive limits; PA758, PA759 are negative limits.																																
PA771	<b>Internal position control switch 3</b>	d.0000~1131		b.0000	Immed																												
	<p>d.</p> <table border="1"> <tr> <td>3</td> <td>2</td> <td>1</td> <td>0</td> </tr> <tr> <td><input type="checkbox"/></td> <td><input type="checkbox"/></td> <td><input type="checkbox"/></td> <td><input type="checkbox"/></td> </tr> </table> <p><b>Homing rotational direction</b></p> <table border="1"> <tr> <td>0</td> <td>Forward rotation</td> </tr> <tr> <td>1</td> <td>Reverse rotation</td> </tr> </table> <p><b>Homing pattern selection</b></p> <table border="1"> <tr> <td>0</td> <td>After contacting zero switch, look for Z pulse by rotating backward</td> </tr> <tr> <td>1</td> <td>After contacting zero switch, look for Z pulse by rotating forward</td> </tr> <tr> <td>2</td> <td>After contacting zero switch, rotate backward, not look for Z pulse</td> </tr> <tr> <td>3</td> <td>After contacting zero point switch, rotate forward, not look for Z pulse</td> </tr> </table> <p><b>Homing completion operation</b></p> <table border="1"> <tr> <td>0</td> <td>Clear all position data</td> </tr> <tr> <td>1</td> <td>Not clear all position data</td> </tr> </table> <p><b>Homing signal selection</b></p> <table border="1"> <tr> <td>0</td> <td>Use ZPS</td> </tr> <tr> <td>1</td> <td>Use Z pulse</td> </tr> </table>	3	2	1	0	<input type="checkbox"/>	<input type="checkbox"/>	<input type="checkbox"/>	<input type="checkbox"/>	0	Forward rotation	1	Reverse rotation	0	After contacting zero switch, look for Z pulse by rotating backward	1	After contacting zero switch, look for Z pulse by rotating forward	2	After contacting zero switch, rotate backward, not look for Z pulse	3	After contacting zero point switch, rotate forward, not look for Z pulse	0	Clear all position data	1	Not clear all position data	0	Use ZPS	1	Use Z pulse				
3	2	1	0																														
<input type="checkbox"/>	<input type="checkbox"/>	<input type="checkbox"/>	<input type="checkbox"/>																														
0	Forward rotation																																
1	Reverse rotation																																
0	After contacting zero switch, look for Z pulse by rotating backward																																
1	After contacting zero switch, look for Z pulse by rotating forward																																
2	After contacting zero switch, rotate backward, not look for Z pulse																																
3	After contacting zero point switch, rotate forward, not look for Z pulse																																
0	Clear all position data																																
1	Not clear all position data																																
0	Use ZPS																																
1	Use Z pulse																																
PA772	<b>Internal position control switch 4</b>	b.0000~1111		b.0000	Immed																												

P	Descriptions	Range	Unit	Defau	Effective	R																		
	<p>b. </p> <table border="1"> <thead> <tr> <th colspan="2">Calculating absolute positions</th> </tr> </thead> <tbody> <tr> <td>0</td> <td>Use feedback position</td> </tr> <tr> <td>1</td> <td>Use reference position</td> </tr> </tbody> </table> <p><b>Reserved</b></p> <table border="1"> <thead> <tr> <th colspan="2">Use of electronic gear for communication position feedback</th> </tr> </thead> <tbody> <tr> <td>0</td> <td>Feedback data 0x0783, 0x0784 as data after electronic gear.</td> </tr> <tr> <td>1</td> <td>Feedback data 0x0783, 0x0784 as motor feedback data to be used with dP 00 and dP 01.</td> </tr> </tbody> </table> <table border="1"> <thead> <tr> <th colspan="2">High/low switchover</th> </tr> </thead> <tbody> <tr> <td>0</td> <td>Same as user manual, 32-bit data not negate</td> </tr> <tr> <td>1</td> <td>Contrary to user manual, 32-bit data negate</td> </tr> </tbody> </table>	Calculating absolute positions		0	Use feedback position	1	Use reference position	Use of electronic gear for communication position feedback		0	Feedback data 0x0783, 0x0784 as data after electronic gear.	1	Feedback data 0x0783, 0x0784 as motor feedback data to be used with dP 00 and dP 01.	High/low switchover		0	Same as user manual, 32-bit data not negate	1	Contrary to user manual, 32-bit data negate					
Calculating absolute positions																								
0	Use feedback position																							
1	Use reference position																							
Use of electronic gear for communication position feedback																								
0	Feedback data 0x0783, 0x0784 as data after electronic gear.																							
1	Feedback data 0x0783, 0x0784 as motor feedback data to be used with dP 00 and dP 01.																							
High/low switchover																								
0	Same as user manual, 32-bit data not negate																							
1	Contrary to user manual, 32-bit data negate																							
PA773	<b>Internal position control switch 5</b>	b.0000~1111		b.0000	Immed																			
	<p>b. </p> <table border="1"> <thead> <tr> <th colspan="2">CLR signal function</th> </tr> </thead> <tbody> <tr> <td>0</td> <td>Only clear position deviation.</td> </tr> <tr> <td>1</td> <td>Clear all position data</td> </tr> </tbody> </table> <table border="1"> <thead> <tr> <th colspan="2">Homing position limit</th> </tr> </thead> <tbody> <tr> <td>0</td> <td>Valid</td> </tr> <tr> <td>1</td> <td>Invalid. Only valid when homing completed after run backwards and find zero point.</td> </tr> </tbody> </table> <p><b>Reserved</b></p> <p><b>Reserved</b></p>	CLR signal function		0	Only clear position deviation.	1	Clear all position data	Homing position limit		0	Valid	1	Invalid. Only valid when homing completed after run backwards and find zero point.											
CLR signal function																								
0	Only clear position deviation.																							
1	Clear all position data																							
Homing position limit																								
0	Valid																							
1	Invalid. Only valid when homing completed after run backwards and find zero point.																							
PA774	<b>Reserved</b>																							
PA775	<b>Homing speed before contacting zero signal</b>	0~3000	rpm	500	Immed																			
PA776	<b>Homing speed after contacting zero signal</b>	0~500	rpm	30	Immed																			
PA777	<b>Zero switch offset low place</b>	h.0000~FFFF	Pulse	0	Immed																			
PA778	<b>Zero switch offset high place</b>	h.0000~1FFF		0	Immed																			
PA779	<b>Positive software limit switch low place</b>	h.0000~FFFF	Pulse	h.0000	Immed																			

P	Descriptions	Range	Unit	Defau	Effective	R
PA780	Positive software limit switch high place	h.0000~FFFF		h.1000	Immed	
PA781	Negative software limit switch low place	h.0000~FFFF	Pulse	h.0000	Immed	
PA782	Negative software limit switch high place	h.0000~FFFF		h.E000	Immed	